

Application of Linux Single Board Computers to Amateur Radio

Willem A Schreüder AC0KQ
willem@prinmath.com

RMHAM University
October 15, 2016

<http://www.prinmath.com/ham/talks/>
<http://www.rmham.org/wordpress/course-syllabus>

Talk Outline

- **Why Linux SBCs**
- **Installing and Configuring the OS**
- **BPQ Packet/RMS Gateway/APRS iGate**
- **AllStarLink Repeater**
- **Control and Monitoring**
- **SDR**
- **Questions and Pizza**
- *Don't freak out over the number of slides. Most of them take 10 seconds to cover.*

Single Board Computers

- **Full Linux boxes (*today's topic*)**
 - Raspberry Pi
 - Beaglebone
- **Microcontrollers (*not covered*)**
 - Arduino
 - PICAXE
 - BASIC Stamp

Why Linux SBCs?

- **Runs a full Linux OS**
- **Usable stand alone computer or server**
- **Built in connectivity**
 - **Ethernet networking**
 - **USB and serial**
 - **General purpose IO**
- **Low power (5V 1A)**
- **Expandable using daughter boards**
- **Inexpensive (\$50 for a working system)**

SBC Pros and Cons

- **Pros**

- **Inexpensive**
- **No moving parts**
- **5V power**
- **Expandable**

- **Cons**

- **SD cards corrupted by bad power**
- **SD card is not a great hard disk**

Raspberry Pi

- **Most Popular**
- **Best supported**
- **rPi3 most powerful**
- **Lots of USB ports**
- **Lots of daughterboards**
- **No analog inputs**
- **\$35 plus SD card**

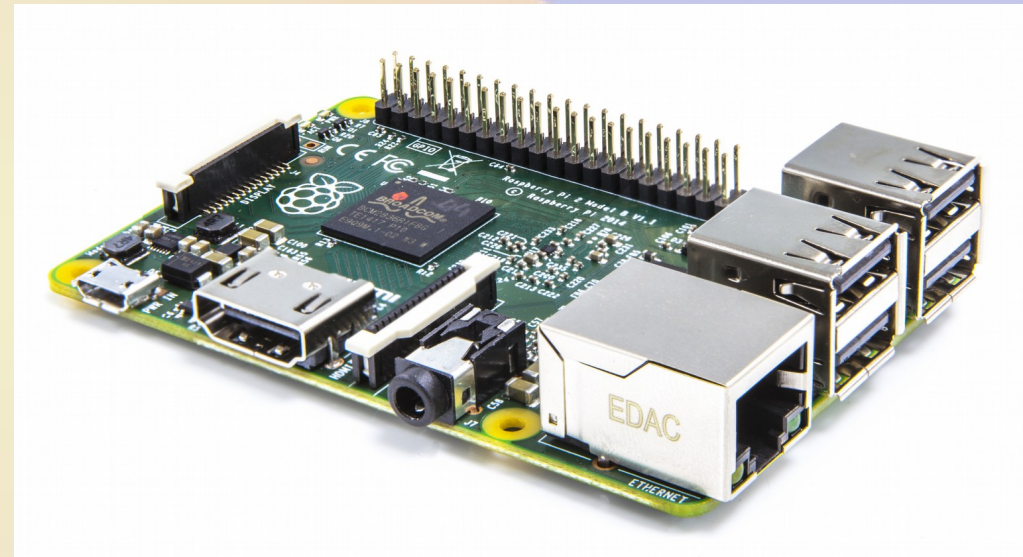

Raspberry Pi models

- **Raspberry Pi**
 - **A/A+ 700 MHz CPU & 256MB SDRAM, 1xUSB**
 - **B 700 MHz CPU & 512MB SDRAM, 2xUSB, Ethernet**
 - **B+ 700 MHz CPU & 512MB SDRAM, 4xUSB, Ethernet**
 - **2B 900 MHz Quad A7 & 1GB SDRAM, 4xUSB, Ethernet**
 - **3B 1.2GHz Quad 64bit & 1GB SDRAM, 4xUSB, Ethernet**
- **Compute Module**
 - **700MHz CPU & 512MB SDRAM**
- **Zero**
 - **1GHz CPU & 512MB SDRAM**

Raspberry Pi 2B

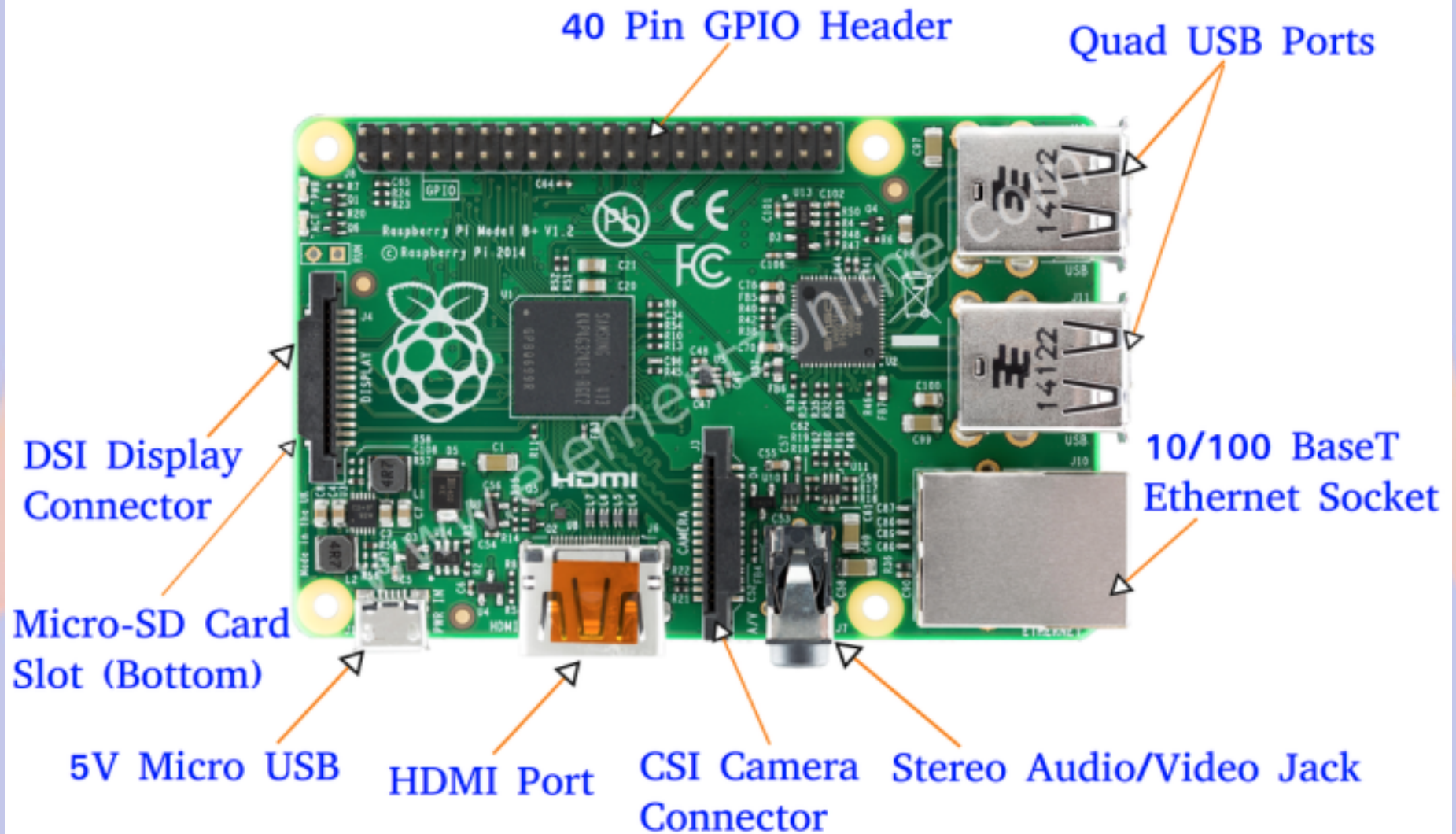

Beagle Bone

- Less well supported
- Onboard eMMC
- Power & Reset buttons
- More GPIO pins
- 8 analog inputs
- \$50 street price



Beaglebone Models

- **White**
 - Original 720 MHz A8
- **Black**
 - Most Popular 1GHz A8
- **Green**
 - Same CPU as Black
 - No barrel power, two Grove connectors
- **Industrial**
 - Black with extended temperature range

Beagle Bone Black

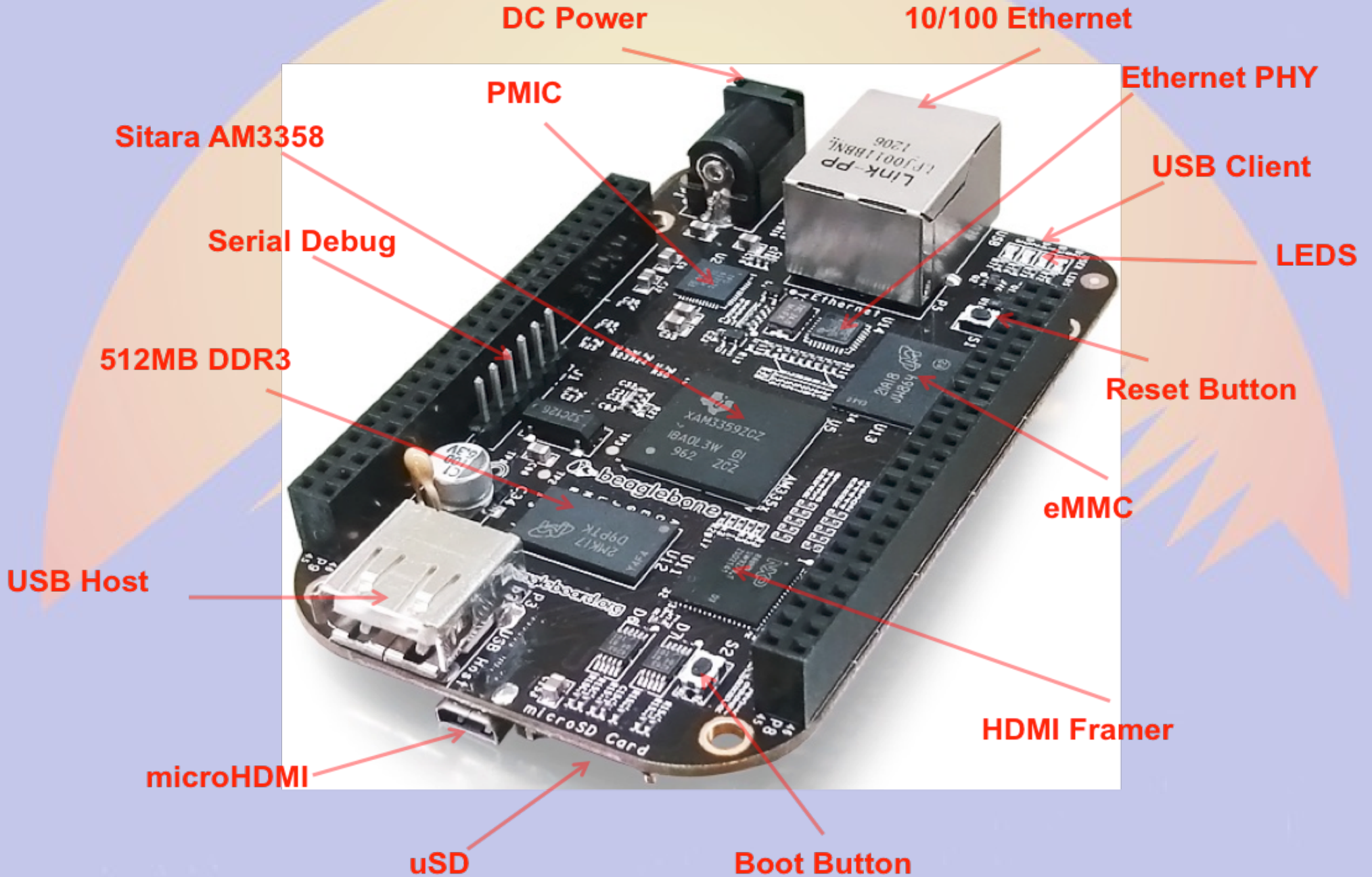

Other Linux SBCs

- **Examples**
 - Intel Edison
 - VoCore
 - Odroid
- **Less well supported**
- **Fewer peripherals**
- **Sometimes better performance**
- **Mostly higher priced**

Power and Storage

- **Runs on 5V DC**
 - Needs clean power
 - Draws 0.5-1.0 A without daughter boards
- **Micro SD card storage**
 - Finite life
 - Marginal performance
 - Bad power kills SD

Must Have Accessories

- **Micro SD card**
 - **Faster is better**
 - Class 10
 - UHS 1
 - UHS 3
 - **At least 4GB**
 - 16GB is ample
- **Real time clock**
 - PiFace Shim RTC
 - Adafruit DS1307
 - Needed if no network (NTP)

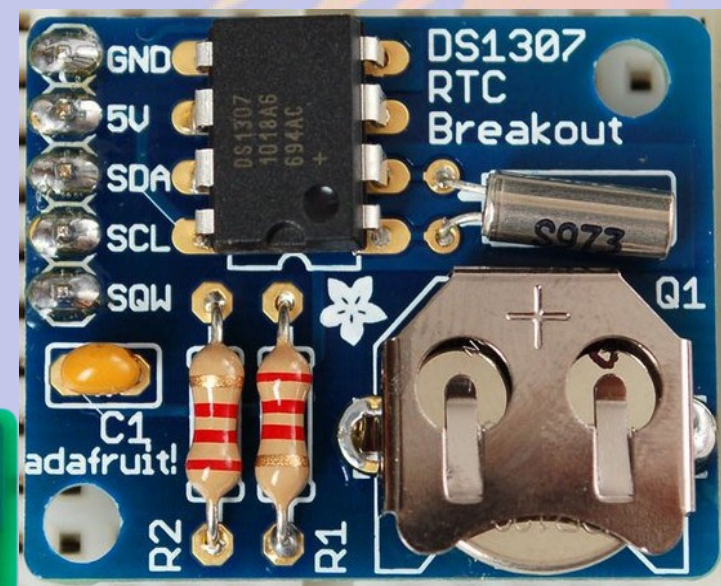
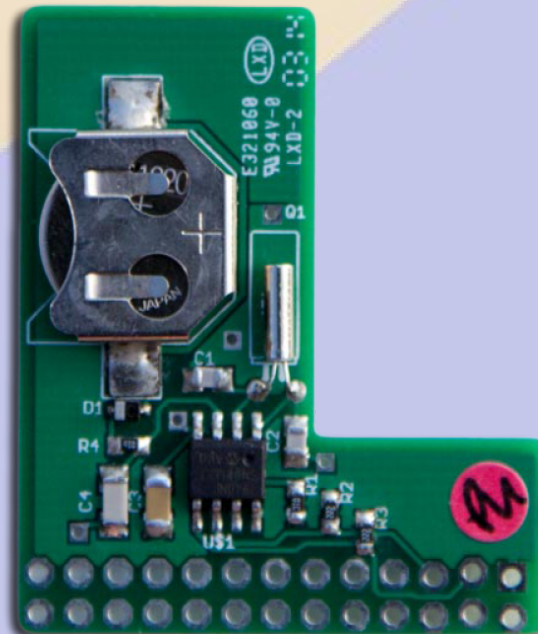

Nice to have

- Official Raspberry 7" Touchscreen



Power Control

- Andice Labs Powercape
- Adafruit Powerboost 1000C
- Charges and boosts 4V from LIPO battery

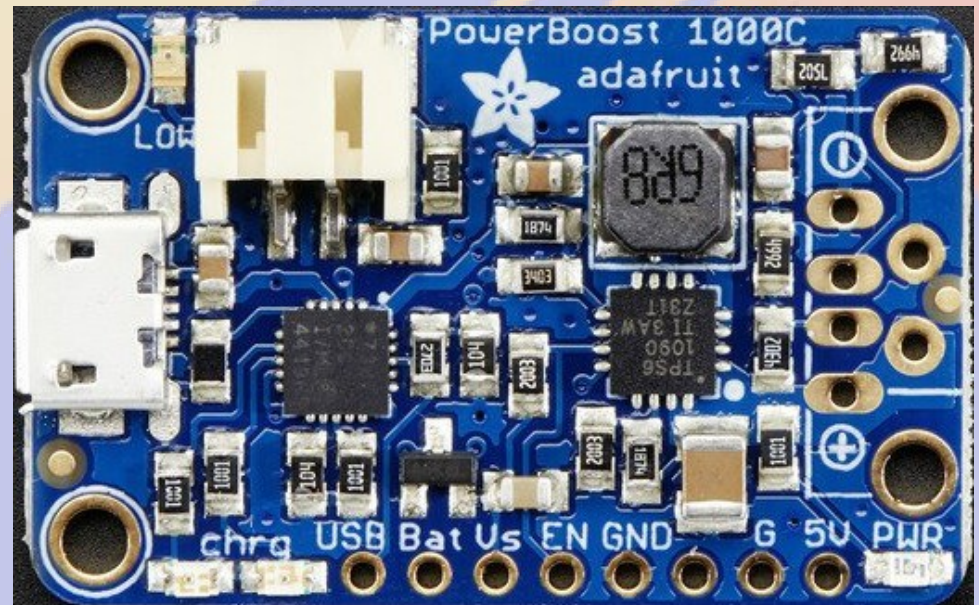
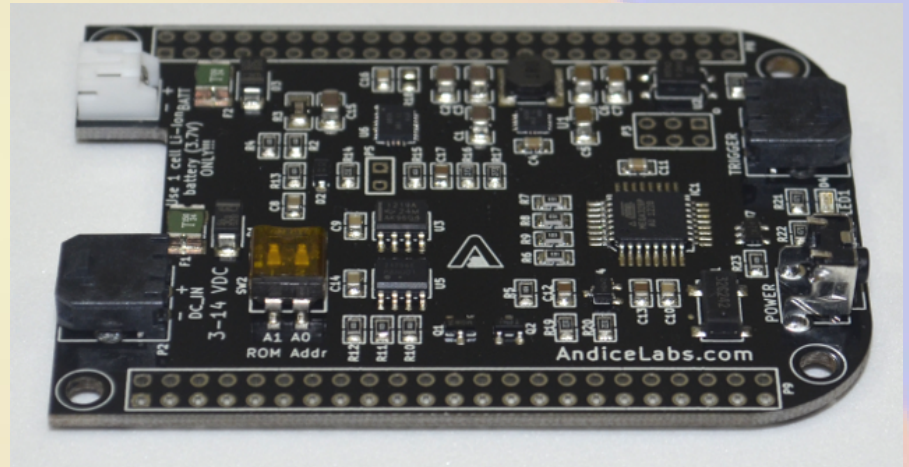

TNC-X/Pi/Black

- Designed by John Hansen W2FS
- Based on PIC Microcontroller
- MX614 Bell 202 modem chip
- KISS interface
 - Serial
 - USB
 - I2C



Why the BB/TNC-Black?

- **BBB has 5 serial ports**
- **Mechanically stable stacked capes**
- **Powercape battery backup**
- **Lots of pins for site monitoring**
- **50% more expensive**

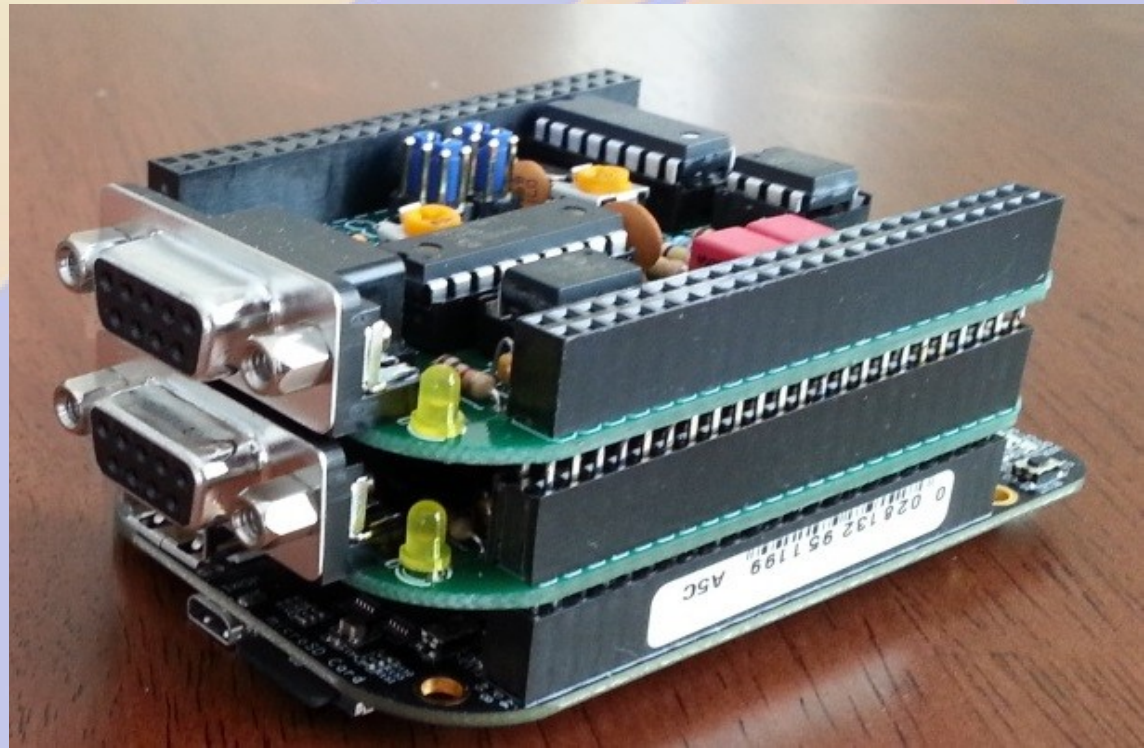

A stylized sun or light source is positioned behind a blue horizon line. The sun is a semi-circle with a gradient from yellow to orange. The background is a solid light blue color.

Part 1a

Getting Started on the Raspberry Pi

rPi Materials

- **Raspberry Pi 2B or 3B**
- **Micro SD card**
- **5V 1A power supply**
- **USB A to micro USB B cable**
- **Ethernet cable**
- **Direct connection**
 - **Monitor or TV**
 - **HDMI cable**
 - **USB keyboard and mouse**

Raspberry OS Choices

- <https://www.raspberrypi.org/downloads/>
- **Debian derivatives are most popular**
 - **Raspbian (Official Supported OS)**
 - **Alternatives are**
 - **NOOBS (New Out Of the Box Software)**
 - **Ubuntu Mate (Ubuntu Desktop)**
 - **Windows 10 IOT (a.k.a. YGBSM)**
 - *several others, some not Linux based*
- **Debian 8 (Jessie) adopts systemd**
 - **This changes how system programs are run**
 - **No more */etc/init.d/XXX* and */etc/inittab***
 - **Control programs with *systemctl***

Burning the Image

- **Unzip image**
 - `2016-09-23-raspbian-jesse.img`
- **Linux or OSX command line**
 - `dd if=2016-09-23-raspbian-jesse.img of=/dev/mmcblk0`
 - `sync;sync`
- **Windows**
 - Download Win32DiskImager
 - Select image file name
 - Select SD card drive letter
 - Click *Write*

First boot with Pixel

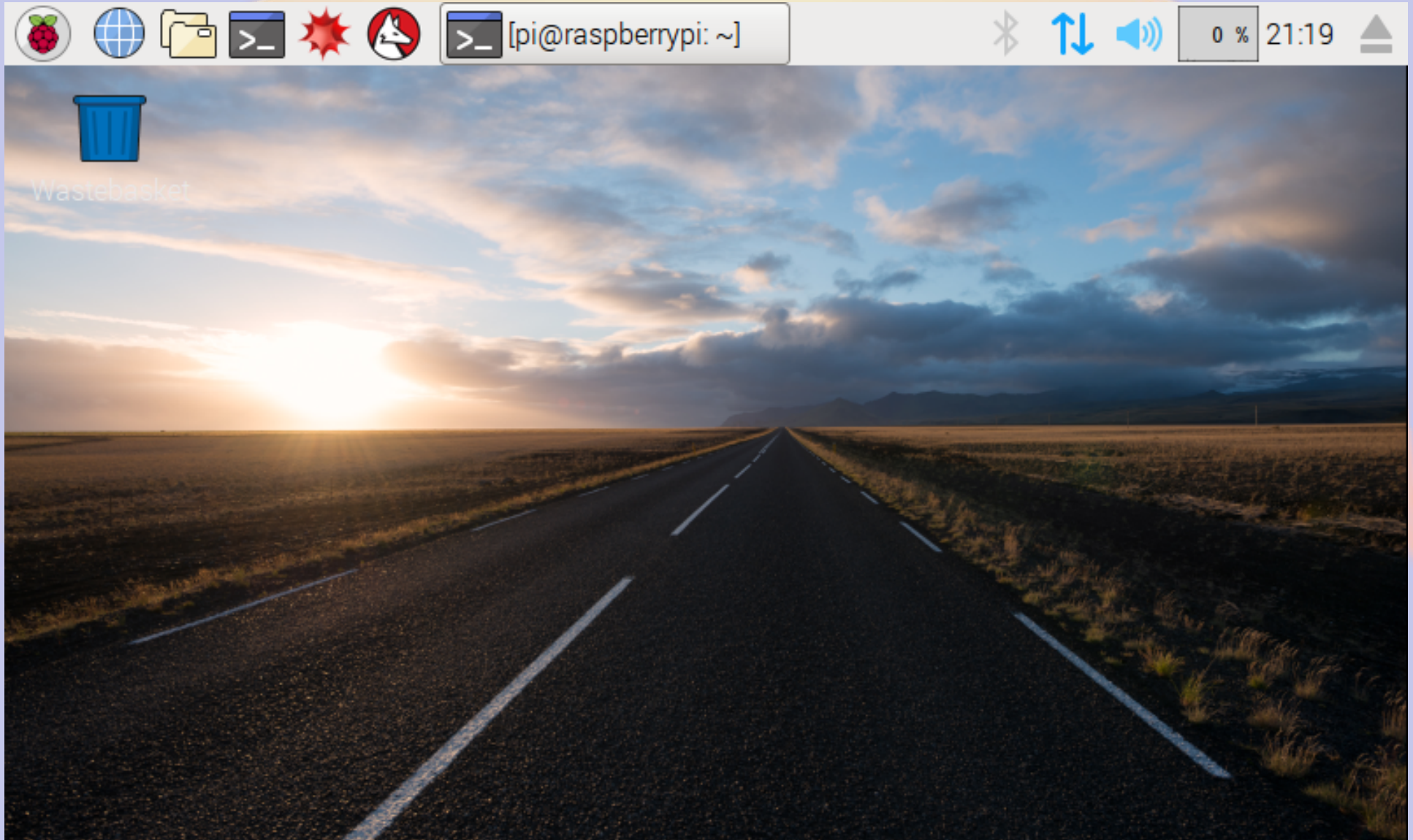

Raspberry > Preferences > Raspberry Pi Configuration

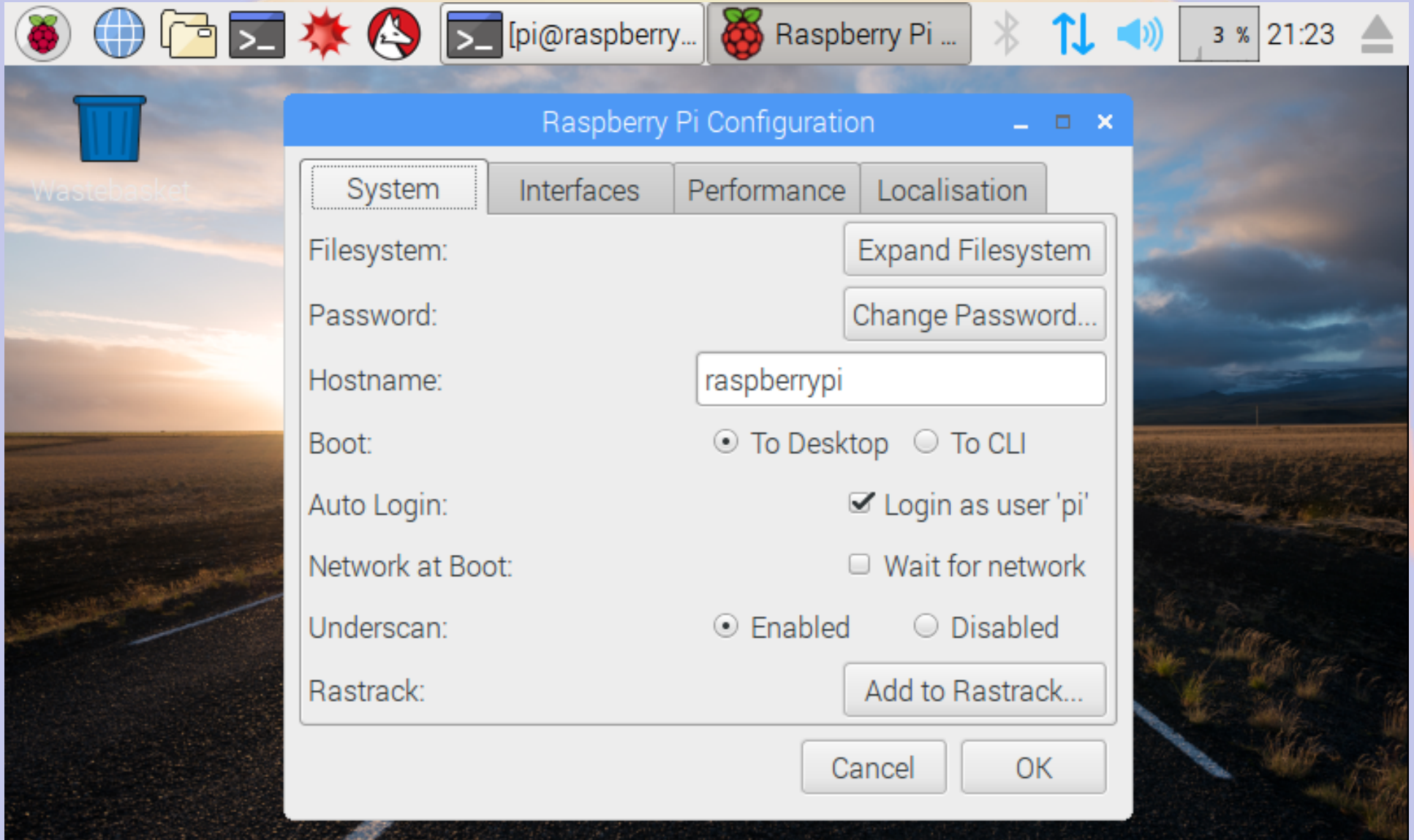

Finding your IP Address

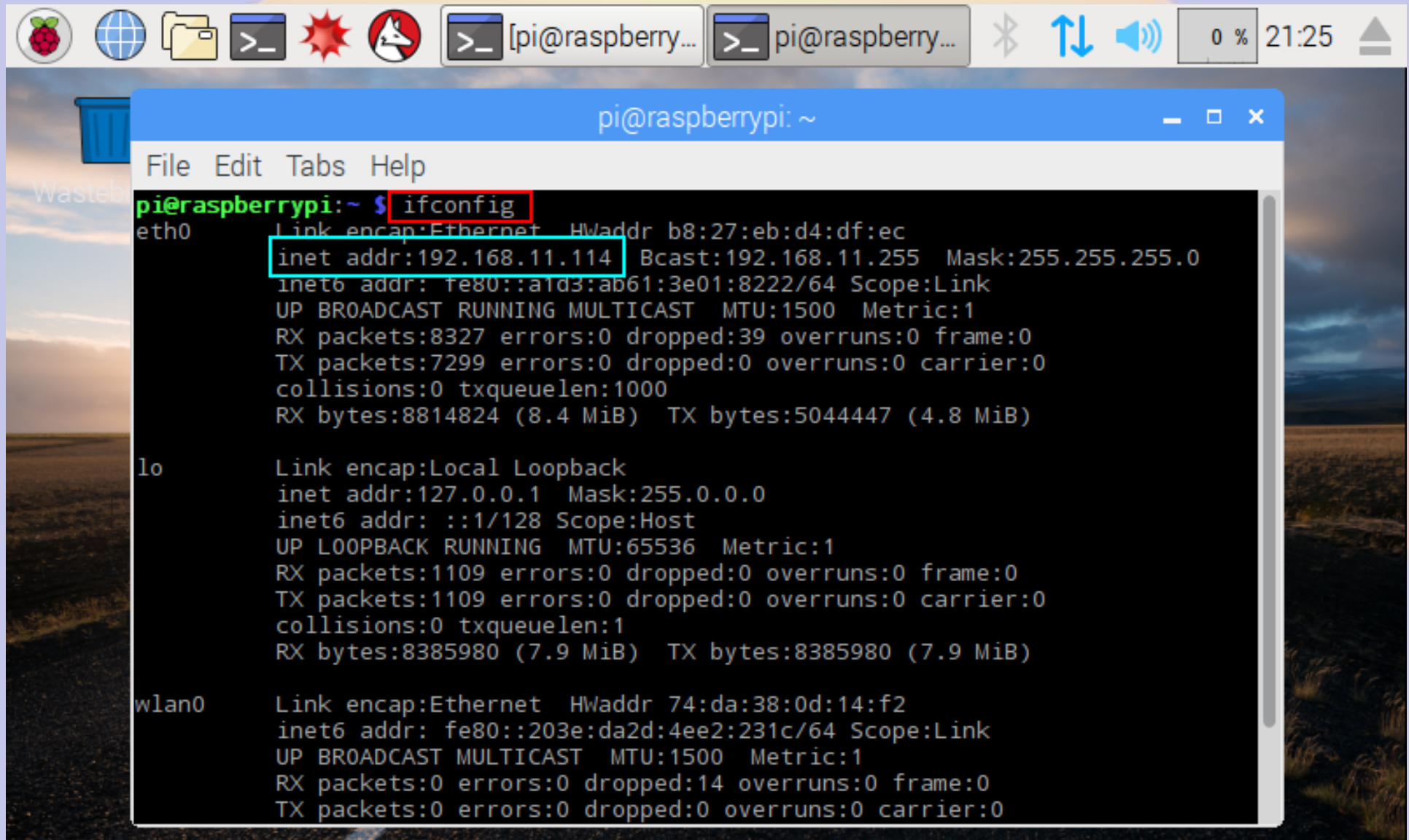

```
pi@raspberrypi:~ $ ifconfig
eth0      Link encap:Ethernet  HWaddr b8:27:eb:d4:df:ec
          inet addr:192.168.11.114  Bcast:192.168.11.255  Mask:255.255.255.0
          inet6 addr: fe80::a1d3:ab61:3e01:8222/64  Scope:Link
          UP BROADCAST RUNNING MULTICAST  MTU:1500  Metric:1
          RX packets:8327 errors:0 dropped:39 overruns:0 frame:0
          TX packets:7299 errors:0 dropped:0 overruns:0 carrier:0
          collisions:0 txqueuelen:1000
          RX bytes:8814824 (8.4 MiB)  TX bytes:5044447 (4.8 MiB)

lo        Link encap:Local Loopback
          inet addr:127.0.0.1  Mask:255.0.0.0
          inet6 addr: ::1/128  Scope:Host
          UP LOOPBACK RUNNING  MTU:65536  Metric:1
          RX packets:1109 errors:0 dropped:0 overruns:0 frame:0
          TX packets:1109 errors:0 dropped:0 overruns:0 carrier:0
          collisions:0 txqueuelen:1
          RX bytes:8385980 (7.9 MiB)  TX bytes:8385980 (7.9 MiB)

wlan0     Link encap:Ethernet  HWaddr 74:da:38:0d:14:f2
          inet6 addr: fe80::203e:da2d:4ee2:231c/64  Scope:Link
          UP BROADCAST MULTICAST  MTU:1500  Metric:1
          RX packets:0 errors:0 dropped:14 overruns:0 frame:0
          TX packets:0 errors:0 dropped:0 overruns:0 carrier:0
```

Remote Access

- Do `ifconfig` from the keyboard
- Look for hostname *raspberrypi*
 - Assign a reserved IP address and add DNS
- Advantages of using `ssh`
 - Can access the device from anywhere
 - Automatic logins using `authorized_keys`
 - Text based menus work great remotely

Configuring rPi

- Plug in keyboard, mouse and screen
 - Menu > Preferences > rPi Configuration
- Plug in ethernet cable and locate the IP address
 - Default hostname is *raspberrypi*
 - ssh **pi@XXX.XXX.XXX.XXX**
 - password raspberry

Running raspi-config

```
pi@raspberrypi: ~  
File Edit View Search Terminal Help  
willem@bashful: ~$ ssh pi@192.168.11.114  
pi@192.168.11.114's password:  
  
The programs included with the Debian GNU/Linux system are free software;  
the exact distribution terms for each program are described in the  
individual files in /usr/share/doc/*/copyright.  
  
Debian GNU/Linux comes with ABSOLUTELY NO WARRANTY, to the extent  
permitted by applicable law.  
Last login: Sat May 7 18:09:16 2016 from 192.168.11.126  
pi@raspberrypi: ~$ sudo raspi-config
```

Expand file system

```
pi@raspberrypi: ~  
File Edit View Search Terminal Help  
  
Raspberry Pi Software Configuration Tool (raspi-config)  
  
1 Expand Filesystem          Ensures that all of the SD card s  
2 Change User Password       Change password for the default u  
3 Boot Options                Choose whether to boot into a des  
4 Wait for Network at Boot   Choose whether to wait for networ  
5 Internationalisation Options Set up language and regional sett  
6 Enable Camera              Enable this Pi to work with the R  
7 Add to Rastrack            Add this Pi to the online Raspber  
8 Overclock                  Configure overclocking for your P  
9 Advanced Options           Configure advanced settings  
0 About raspi-config         Information about this configurat  
  
                <Select>                <Finish>
```

Change the Password

```
pi@raspberrypi: ~  
File Edit View Search Terminal Help  
  
Raspberry Pi Software Configuration Tool (raspi-config)  
  
1 Expand Filesystem          Ensures that all of the SD card s  
2 Change User Password       Change password for the default u  
3 Boot Options               Choose whether to boot into a des  
4 Wait for Network at Boot   Choose whether to wait for networ  
5 Internationalisation Options Set up language and regional sett  
6 Enable Camera              Enable this Pi to work with the R  
7 Add to Rastrack            Add this Pi to the online Raspber  
8 Overclock                  Configure overclocking for your P  
9 Advanced Options           Configure advanced settings  
0 About raspi-config         Information about this configurat  
  
                <Select>                <Finish>
```

Set timezone 1

```
pi@raspberrypi: ~  
File Edit View Search Terminal Help  
  
Raspberry Pi Software Configuration Tool (raspi-config)  
  
1 Expand Filesystem          Ensures that all of the SD card s  
2 Change User Password       Change password for the default u  
3 Boot Options                Choose whether to boot into a des  
4 Wait for Network at Boot    Choose whether to wait for networ  
5 Internationalisation Options Set up language and regional sett  
6 Enable Camera               Enable this Pi to work with the R  
7 Add to Rastrack             Add this Pi to the online Raspber  
8 Overclock                   Configure overclocking for your P  
9 Advanced Options           Configure advanced settings  
0 About raspi-config          Information about this configurat  
  
                <Select>                <Finish>
```

Set timezone 2

```
pi@raspberrypi: ~  
File Edit View Search Terminal Help  
  
Raspberry Pi Software Configuration Tool (raspi-config)  
  
I1 Change Locale          Set up language and regional sett  
I2 Change Timezone       Set up timezone to match your loc  
I3 Change Keyboard Layout Set the keyboard layout to match  
I4 Change Wi-fi Country  Set the legal channels used in yo  
  
<Select>                <Back>
```

Advanced Options

```
pi@raspberrypi: ~  
File Edit View Search Terminal Help  
  
Raspberry Pi Software Configuration Tool (raspi-config)  
  
1 Expand Filesystem          Ensures that all of the SD card s  
2 Change User Password       Change password for the default u  
3 Boot Options                Choose whether to boot into a des  
4 Wait for Network at Boot   Choose whether to wait for networ  
5 Internationalisation Options Set up language and regional sett  
6 Enable Camera              Enable this Pi to work with the R  
7 Add to Rastrack            Add this Pi to the online Raspber  
8 Overclock                  Configure overclocking for your P  
9 Advanced Options           Configure advanced settings  
0 About raspi-config         Information about this configurat  
  
                <Select>                <Finish>
```

Set Hostname

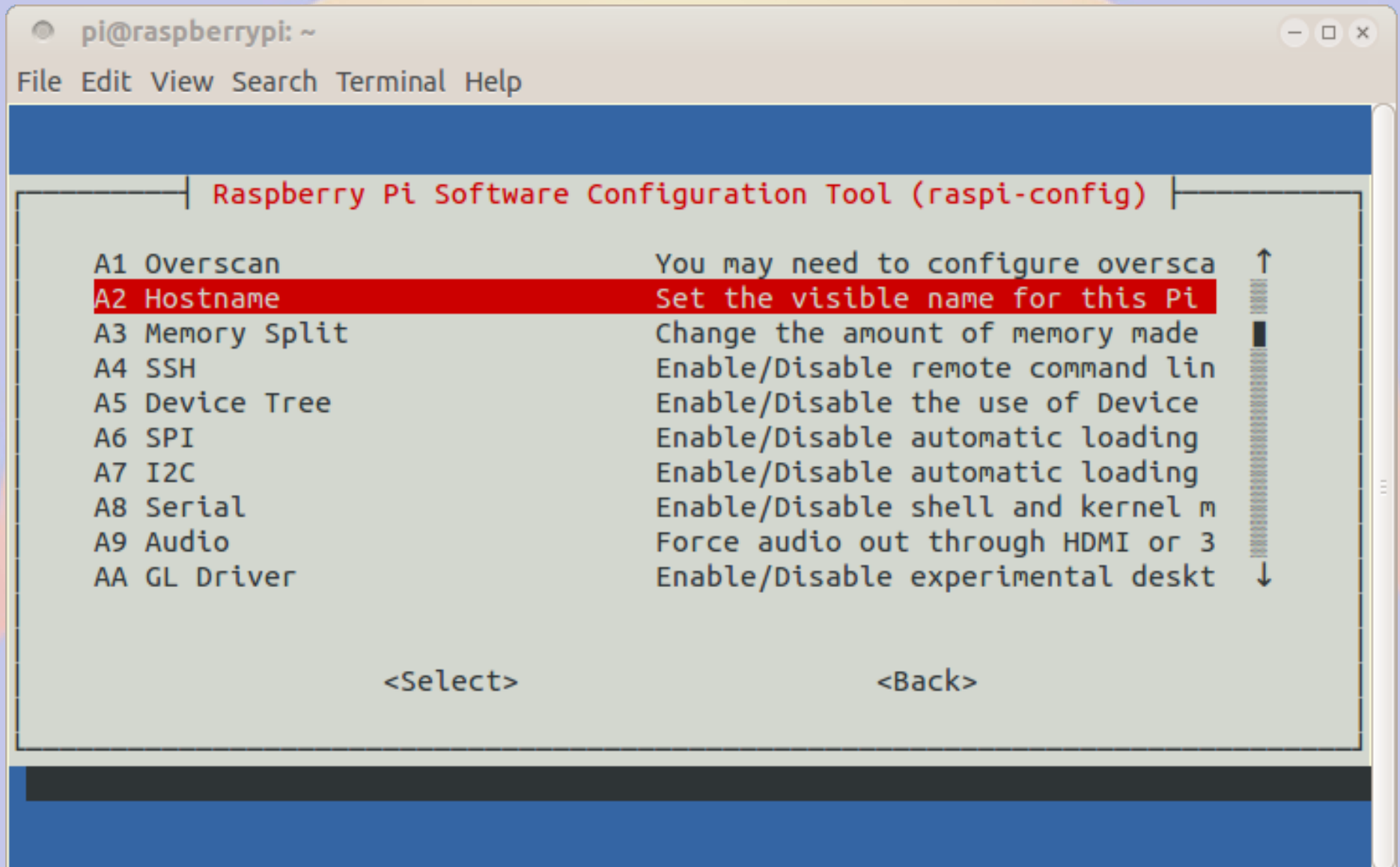

Disable serial login

```
pi@raspberrypi: ~  
File Edit View Search Terminal Help  
Raspberry Pi Software Configuration Tool (raspi-config)  
A1 Overscan You may need to configure oversca ↑  
A2 Hostname Set the visible name for this Pi  
A3 Memory Split Change the amount of memory made  
A4 SSH Enable/Disable remote command lin  
A5 Device Tree Enable/Disable the use of Device  
A6 SPI Enable/Disable automatic loading  
A7 I2C Enable/Disable automatic loading  
A8 Serial Enable/Disable shell and kernel m  
A9 Audio Force audio out through HDMI or 3  
AA GL Driver Enable/Disable experimental desk ↓  
  
<Select> <Back>
```

Reboot and log in again

```
pi@raspberrypi: ~  
File Edit View Search Terminal Help  
  
Raspberry Pi Software Configuration Tool (raspi-config)  
  
1 Expand Filesystem          Ensures that all of the SD card s  
2 Change User Password       Change password for the default u  
3 Boot Options               Choose whether to boot into a des  
4 Wait for Network at Boot   Choose whether to wait for networ  
5 Internationalisation Options Set up language and regional sett  
6 Enable Camera              Enable this Pi to work with the R  
7 Add to Rastrack            Add this Pi to the online Raspber  
8 Overclock                  Configure overclocking for your P  
9 Advanced Options           Configure advanced settings  
0 About raspi-config         Information about this configurat  
  
<Select>                    <Finish>
```

Add user willem

```
pi@aid2: ~  
File Edit View Search Terminal Help  
pi@aid2:~$ sudo adduser willem  
Adding user `willem' ...  
Adding new group `willem' (1001) ...  
Adding new user `willem' (1001) with group `willem' ...  
Creating home directory `/home/willem' ...  
Copying files from `/etc/skel' ...  
Enter new UNIX password:  
Retype new UNIX password:  
passwd: password updated successfully  
Changing the user information for willem  
Enter the new value, or press ENTER for the default  
Full Name []: Willem AC0KQ  
Room Number []:  
Work Phone []:  
Home Phone []:  
Other []:  
Is the information correct? [Y/n]  
pi@aid2:~$ sudo adduser willem sudo  
Adding user `willem' to group `sudo' ...  
Adding user willem to group sudo  
Done.  
pi@aid2:~$
```

Install required packages

```
pi@aid2: ~  
File Edit View Search Terminal Help  
pi@aid2:~$ sudo apt-get install vim telnet minicom  
Reading package lists... Done  
Building dependency tree  
Reading state information... Done  
The following extra packages will be installed:  
  lrzsz vim-runtime  
Suggested packages:  
  ctags vim-doc vim-scripts  
The following NEW packages will be installed:  
  lrzsz minicom telnet vim vim-runtime  
0 upgraded, 5 newly installed, 0 to remove and 0 not upgraded.  
Need to get 6,252 kB of archives.  
After this operation, 29.3 MB of additional disk space will be used.  
Do you want to continue? [Y/n] 
```



Part 1b
Getting Started on the
Beaglebone Black

Beaglebone Materials

- **Beaglebone Black or Green**
- **Micro SD card**
- **5V 1A power supply**
- **USB A to mini USB B cable or barrel connector**
- **Ethernet cable**
- **Direct connection**
 - **Monitor or TV**
 - **HDMI to micro HDMI cable**
 - **USB keyboard and mouse**

Beaglebone OS Choices

- <http://beagleboard.org/latest-images>
- **Debian 8 Jessie**
 - Linux Kernel 4.4 (Jesse 8.4)
- **Debian 7 Wheezy**
 - Linux Kernel 3.8 (Wheezy 7.11)
- **I have had trouble with Jessie on the BBB, so use Wheezy for now**

Burning the Image

- **Images are compressed with xz**
 - p7zip on windows
 - xz-utils on Linux
- **Uncompress image (Linux)**
 - `xz -d bone-debian-*.img.xz`
- **Burn image using dd or Win32DiskImager**

Beaglebone Resize Image

```
File Edit View Search Terminal Help
willem@bashful:~$ ssh root@192.168.11.88
Debian GNU/Linux 7

BeagleBoard.org Debian Image 2016-06-15

Support/FAQ: http://elinux.org/Beagleboard:BeagleBoneBlack\_Debian

default username:password is [debian:temppwd]

Last login: Thu Oct 13 01:33:30 2016 from bashful.local
root@beaglebone:~# /opt/scripts/tools/grow_partition.sh
Media: [/dev/mmcblk0]

Disk /dev/mmcblk0: 474880 cylinders, 4 heads, 16 sectors/track
Old situation:
Warning: The partition table looks like it was made
  for C/H/S=*/112/62 (instead of 474880/4/16).
For this listing I'll assume that geometry.
Units = mebibytes of 1048576 bytes, blocks of 1024 bytes, counting from 0

  Device Boot Start   End   MiB   #blocks   Id System
/dev/mmcblk0p1 *     1  3399   3399   3480576   83 Linux
                start: (c,h,s) expected (0,33,3) found (0,32,33)
                end: (c,h,s) expected (1002,85,42) found (433,111,62)
```

Reboot to apply resize

Beaglebone Configuration

```
File Edit View Search Terminal Help
root@beaglebone:~# dpkg-reconfigure tzdata

Current default time zone: 'America/Denver'
Local time is now:      Wed Oct 12 19:51:11 MDT 2016.
Universal Time is now:  Thu Oct 13 01:51:11 UTC 2016.

root@beaglebone:~# sed -i -e 's/beaglebone/bpqconifer/g' /etc/hostname /etc/hosts

root@beaglebone:~# apt-get -qq update
root@beaglebone:~# apt-get install telnet unzip minicom
Reading package lists... Done
Building dependency tree
Reading state information... Done
The following extra packages will be installed:
 lrzsz
Suggested packages:
 zip
The following NEW packages will be installed:
 lrzsz minicom telnet unzip
0 upgraded, 4 newly installed, 0 to remove and 60 not upgraded.
Need to get 672 kB of archives.
After this operation, 1 551 kB of additional disk space will be used.
Do you want to continue [Y/n]? 
```

Beaglebone User Configuration

- **Set root and debian passwords**
 - `passwd`
 - `passwd debian`
- **Add additional user(s)**
 - `adduser willem`
 - `adduser willem sudo`



Part 1c

Getting around in Linux

Command Line Basics

- **ls** list files
- **cd** change directory
- **cp** copy file(s)
- **mv** move file(s)
- **rm** remove file(s)
- **mkdir** make new directory
- **rmdir** remove directory
- **sudo** run the command as root
- **man** help
- *Command line parameters start with -*

Customizing your environment

- **Create a file named `.bashrc` in your home directory**
 - **`alias cp='cp -i'`**
 - **`alias mv='mv -i'`**
 - **`alias rm='rm -i'`**
 - **`export PATH=$PATH:/new/location`**
- **Files starting with `.` (period) are hidden unless you do `ls -a`**

Software Maintenance

- **apt-get update**
 - Download index of latest software available
- **apt-get upgrade**
 - Upgrade all packages to latest versions
- **apt-get install *foo***
 - Install package *foo*
- **apt-get remove *foo***
 - Remove package *foo*

Editing files

- **leafpad** **rPi editor**
- **nano** **Easy to use**
- **vi/vim/gvim** **The editor for real men**
- **emacs** **For uber-nerds**
- **BPQ has an editor built into the web interface to update bpq32.cfg**



Part 2
BPQ BBS/RMS/iGate

What is BPQ?

- **NET/ROM compatible Packet Switch**
 - **Multiple ports**
 - **As many I2C or serial ports as you have available**
 - **Multiple protocols**
 - **Packet, Pactor, IP**
 - **Multiple functions**
 - **BBS, Chat, APRS**

What can we use BPQ for?

- **AX25 (Packet) Access point**
- **Bulletin Board System (BBS)**
- **Radio Message Server (RMS)**
- **APRS Internet Gateway**
- **Application Gateway**

BPQ Web Configuration

The screenshot shows a Mozilla Firefox browser window titled "K0NTS's BPQ32 Web Server - Mozilla Firefox". The address bar displays "ctnpi:8080/Node/NodeIndex.html". The page content features a large heading "BPQ32 Node K0NTS" and a horizontal menu of navigation links. The browser's toolbar includes a search bar, star icon, and various utility icons.

Routes	Nodes	Ports	Links	Users	Stats	Terminal	Driver Windows	Stream Status	Mail Server Pages	Chat Server Pages	SYSOP Signin	Edit Config
------------------------	-----------------------	-----------------------	-----------------------	-----------------------	-----------------------	--------------------------	--------------------------------	-------------------------------	-----------------------------------	-----------------------------------	------------------------------	-----------------------------

BBS Message Page

Browser window: Edit Messages - Chromium
URL: ctnpi:8080/Mail/Msgs?M000039592D06

BPQ32 BBS K0NTS

[Status](#) [Configuration](#) [Users](#) [Messages](#) [Forwarding](#) [Welcome Msgs & Prompts](#) [Housekeeping](#) [WP Update](#) [Node Menu](#)

Filter

From:
To:
Via:

- [2504](#)
- [2503](#)
- [2498](#)
- [2497](#)
- [2494](#)
- [2493](#)
- [2492](#)
- [2491](#)
- [2486](#)
- [2485](#)
- [2483](#)
- [2482](#)
- [2481](#)

Message 2555

From: AC0KQ Sent: 08-May 21:40Z Type: P
To: K0TER Received: 08-May 21:40Z Status: F
Via:
Title: QTC 1 PHILA PA 215 276
Last Changed: 08-May 21:41Z Size: 210

Green = Sent, Yellow = Queued

K0NTS	RMS						
-------	-----	--	--	--	--	--	--

Message Forwarding

Browser: Mozilla Firefox
Page Title: Edit Forwarding
URL: ctnpi:8080/Mail/FWD?M000038DD423A

BPQ32 BBS K0NTS

[Status](#) [Configuration](#) [Users](#) [Messages](#) [Forwarding](#) [Welcome Msgs & Prompts](#) [Housekeeping](#) [WP Update](#) [Node Menu](#)

Max size to Send
99999

Max Size to Receive
99999

Max age for Bulls
365

Warn if no route for P or T

Use Local Time

Aliases

Forwarding Config for RMS - 0 Messages Queued

TO	AT	TIMES	Connect Script
RMS K0TER K6HTN N1IQI AL7N NX9K			RMS

Hierarchical Routes (Flood Bulls) HR (Personals and Directed Bulls)

--	--

BBS HA

Enable Forwarding Interval (Secs)

Request Reverse Interval (Secs)

Send new messages without waiting for poll timer

FBB Max Block Send Personal Mail Only

Allow Binary Use B1 Protocol Use B2 Protocol

Send ctrl/Z instead of /ex in text mode forwarding

APRS Page

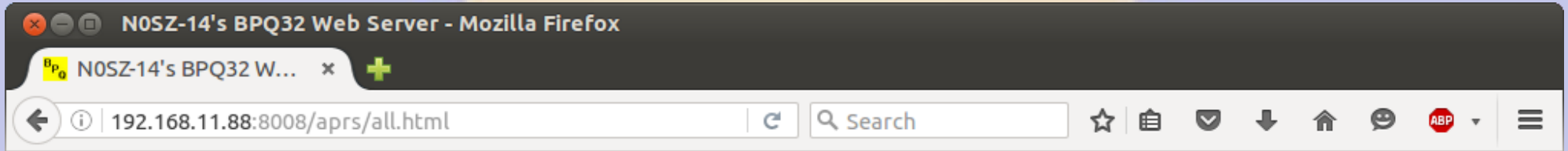

- [Home](#)
- [All Stations](#)
- [RF Stations](#)
- [All WX Stations](#)
- [RF WX Stations](#)
- [All Mobile Stations](#)
- [RF Mobile Stations](#)
- [All Objects](#)
- [RF Objects](#)
- [Information](#)
- [Node Pages](#)

N0SZ-14's BPQ32 APRS Web Server

All Stations

(This page will automatically refresh every five minutes)

The following is a list of all the stations heard in the past 120 minutes, both on RF and on the internet.

There are 90 callsigns in the list, click a callsign to get an information page for that station.

AC0VP-10	AC0XW-1	AC0YV-9	AD0WB-B	AE5VQ	ALMGRE	BVILLE	K0BAN
K0HEY-9	K0JSC-1	K0QED	K0QED-10	K0RTS-9	K1DDN-4	K7HRO-9	K7RFW-9
K7YE-3	K8ZTT-9	KB0JIT	KB0USF	KB9UZO-9	KC0D	KC0D-6	KC0FAC-7
KC0LAD-1	KC0WUV	KC6ETE-9	KD0FPY-9	KD0JZX-10	KD0KVJ-15	KD0LAC-10	KD0SQA-4
KD0SQA-9	KE0GDJ-7	KG4JAM	KI4GYZ-1	KJ0CFW-9	KN0MAP-1	KT0AM-9	N0BN-1
N0EB	N0LNE	N0OJ	N0RUX-13	N0SZ-14	N0SZ-2	N0WAR-9	N0WGM-3
N1GEP-1	N2XGL-5	N2XGL-9	N3GPS	N4ATA-7	N4JJR-9	N7GN-5	N7MJ-9
N7SOI-9	NOADM	SAG1	W0AKO-B	W0ARP	W0BSP-10	W0BSP-13	W0CDS-A
W0CDS-B	W0CDS-C	W0DPD-1	W0JAW	W0JAW-9	W0JRL-15	W0LRA-5	W0QEY-5
W0RDR-9	W0UPS-5	W8XAL-10	W8XAL-9	WA0GEH	WA0TOG	WA5VRL	WA6IFI-3
WB5PJB-B	WB7GR-3	WB7GR-9	WD4IXD	WD4IXD-10	WQ8M-1	WQ8M-9	WR0AEN-B
WR0AEN-D	WY7ATH-2						

Stations Heard on RF

N0SZ-14's BPQ32 Web Server - Mozilla Firefox

N0SZ-14's BPQ32 W... x +

192.168.11.88:8008/aprs/allrf.html Search ☆ 📁 🛡️ ⬇️ 🏠 🗨️ ABP ☰

N0SZ-14's BPQ32 APRS Web Server

RF Stations

(This page will automatically refresh every five minutes)

The following is a list of all the stations heard on RF in the past 120 minutes.

* after a callsign means that it was heard via a digi

The list only includes callsigns heard on RF, direct or via digipeaters.

It does not include callsigns heard on the internet, or heard as third-party RF traffic via IGATEs.

There are 47 callsigns in the list, click a callsign to get an information page for that station.

Callsign	Symbol	Location	Miles	Bearing	Last heard
ALMGRE*	No. Digi	38°46.33'N 104°59.55'W	54.9	159	16:31:27
K0BAN*	Truck	40°24.41'N 105°05.68'W	62.9	12	16:37:20
K0JSC-1*	No. Digi	38°13.86'N 104°36.65'W	97.3	156	16:30:12
K0QED*	Rec Veh'le	38°58.91'N 104°32.53'W	56.9	130	16:32:21
K0QED-10*	No. Diam'd	38°59.87'N 104°38.52'W	52.1	133	15:55:59
K0RTS-9*	Truck	39°17.25'N 103°30.01'W	100.0	99	15:57:58
K1DDN-4*	Car	38°25.62'N 105°11.37'W	75.8	173	16:06:07
K7HRO-9*	Truck	41°09.63'N 104°47.80'W	117.1	14	16:21:42
K7RFW-9*	Van	41°33.88'N 106°08.23'W	147.3	344	16:39:01
K7YE-3*	Truck	40°24.43'N 104°49.41'W	67.5	24	16:11:59
K8ZTT-9*	Jeep	38°59.63'N 105°03.46'W	39.4	157	16:24:34

Station Map

N0SZ-14's BPQ32 Web Server - Mozilla Firefox

N0SZ-14's BPQ32 W... x +

192.168.11.88:8008/aprs/find.cgi?call=N0SZ-2

Search

Home

All Stations

RF Stations

All WX Stations

RF WX Stations

All Mobile Stations

RF Mobile Stations

All Objects

RF Objects

Information

Node Pages

N0SZ-14's BPQ32 APRS Web Server

(This page will automatically refresh every five minutes)

Information about [N0SZ-2](#)

Click the callsign to look it up on qrz.com
Location: 40°07.91'N 104°55.75'W
The bearing from N0SZ-14 to N0SZ-2 is 028 degrees, the distance is 47.9 Miles

Last posit: APTT4,W0UPS-5,WIDE1,KC0D,WIDE2*

Status: /TinyTrak4 Alpha
Last heard 00:54:36 ago

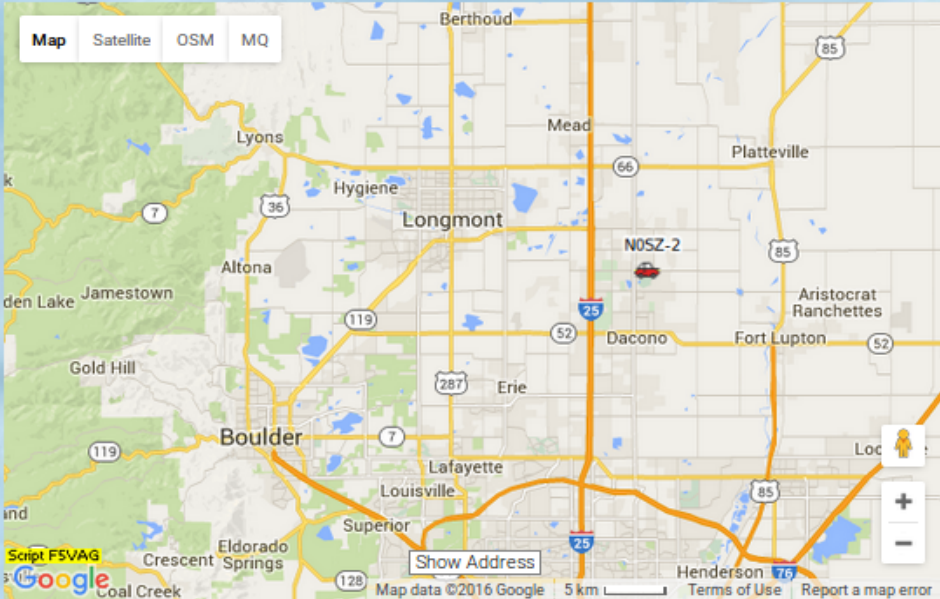

Map Satellite OSM MQ

Script FSVAG

Google

Map data ©2016 Google 5 km Terms of Use Report a map error

How does it work?

- **BPQ is a software program**
 - Runs on most computers
 - Somewhat complex configuration file
- **Connects to radio via Terminal Node Controller (TNC)**
 - Typically serial connection
- **Interconnects via IP**
- **Built-in BBS, iGate, Chat server, ...**

rPi/BPQ vs. KPC3+ BBS

- **rPi/BPQ Pros**

- Lower cost (\$100)
- Much larger capacity (GB vs. kB)
- More ports (multiple RF, serial and IP)
- Sophisticated forwarding

- **rPi/BPQ Cons**

- Higher current draw
- Less tolerant of bad power

Complaint: Hard to set up BPQ

- **BPQ is very sophisticated, and that necessarily adds complexity**
- **Solutions:**
 - **Use *bpq-config* to get started**
 - **Web interface for BBS etc.**
 - **Join a support group**
 - **Yahoo BPQ32**
 - **RMHAM**

Why so rPi and BBB centric?

- **BPQ is software – runs anywhere**
 - **Supported on Windows, OSX, Linux**
 - **Best run as a headless server**
- **rPi and BBB are**
 - **Inexpensive**
 - **Reliable Linux boxes**
 - **DC powered**
 - **TNC/Pi & TNC/Black daughter boards**
 - **All the cool kids have one**

Why the rPi/TNC-Pi?

- Extremely well supported
- Complete package with screen

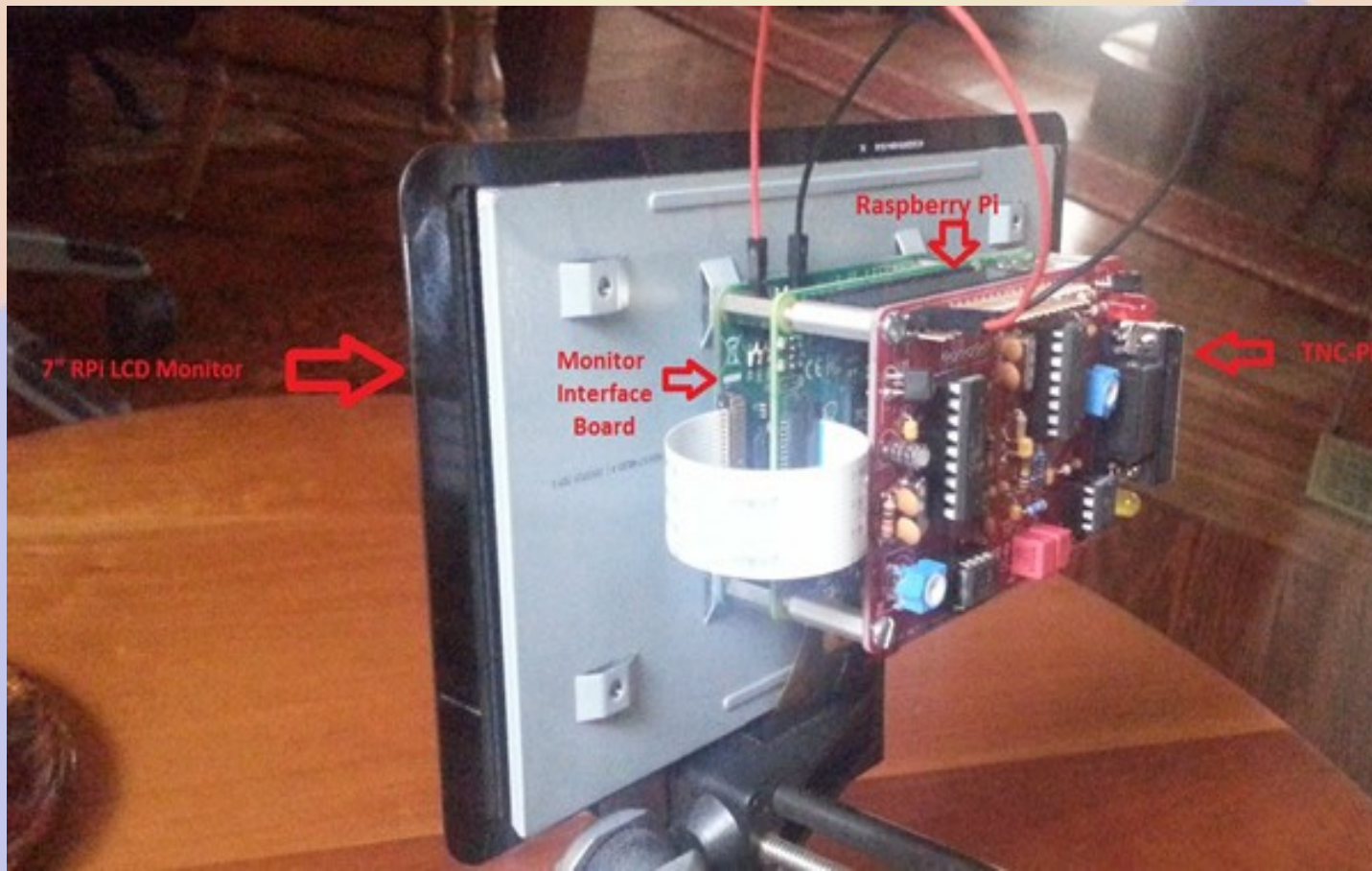

Brief history of BPQ

- **Written by John Wiseman G8BPQ**
- **Originally called BPQCODE**
- **Became BPQ32 in late 90s**
- **Ported to OSX/Linux in 2000s**
- **Ported to Raspberry Pi/TNC-PI and Beagle Bone Black/TNC-Black**

Building the TNC kit

- **It takes a few hours to build**
 - **Quality soldering iron time**
 - **Simple, excellent instructions**
- **Test it**
 - **Check voltages, insert ICs**
 - **LEDs should flash on power up**
 - **Configure OS and BPQ**
- **John W2FS provides outstanding after-sales support**

Selecting a Username

- **Default user name**
 - Raspberry Pi = pi
 - Beaglebone Black = debian
- **The default user name is good for BPQ and similar programs with multiple users**
- **Create a login for each user**
- **Create subdirectories for programs like BPQ which will clutter the home directory**

Download and run bpq-config

```
File Edit View Search Terminal Help
pi@aid2:~ $ mkdir BPQ
pi@aid2:~ $ cd BPQ
pi@aid2:~/BPQ $ wget -q http://www.prinmath.com/ham/bpq-config
pi@aid2:~/BPQ $ chmod a+x bpq-config
pi@aid2:~/BPQ $ sudo ./bpq-config 
```

Download BPQ

(Can also be used to update BPQ)

File Edit View Search Terminal Help

AC0KQ bpq-config version 1.0

Installation Steps

Select next step

- 1 Download BPQ
- 2 Configure BPQ
- 3 About bpq-config

<Select>

<Finish>

Configure BPQ

File Edit View Search Terminal Help

AC0KQ bpq-config version 1.0

Installation Steps

Select next step

- 1 Download BPQ
- 2 Configure BPQ**
- 3 About bpq-config

<Select>

<Finish>

Node Configuration

File Edit View Search Terminal Help

AC0KQ bpq-config version 1.0

Configuration Steps

Select next step

1 Node Configuration

2 Port configuration

3 Telnet users

4 AXIP Node Maps

5 Write Configuration

<Select>

<Finish>

Node Callsign 1

File Edit View Search Terminal Help

AC0KQ bpq-config version 1.0

Node Configuration	
Set Parameter	
Node Callsign	↑
Owner Acronym	█
Owner Name	
Grid Square	
Telnet Port	8010
FBB Port	8011
HTTP Port	8008
AXIP Port	10093
AXIP AutoAdd	Yes
WinLink RMS	↓

<Set> <Finish>

Node Callsign 2

File Edit View Search Terminal Help

AC0KQ bpq-config version 1.0

Node Callsign

Enter Node Callsign e.g. K0NTS (no -1 or -10)

N0SZ

<Ok>

<Cancel>

Owner Acronym 1

File Edit View Search Terminal Help

AC0KQ bpq-config version 1.0

Node Configuration	
Set Parameter	
Node Callsign	N0SZ
Owner Acronym	
Owner Name	
Grid Square	
Telnet Port	8010
FBB Port	8011
HTTP Port	8008
AXIP Port	10093
AXIP AutoAdd	Yes
WinLink RMS	

<Set> <Finish>

Owner Acronym 2

File Edit View Search Terminal Help

AC0KQ bpq-config version 1.0

Owner Acronym

Enter Owner Acronym 1-4 letters, e.g. CTN, used in prompts and alternate callsigns

RMH

<Ok>

<Cancel>

Owner Name 1

File Edit View Search Terminal Help

AC0KQ bpq-config version 1.0

Node Configuration	
Set Parameter	
Node Callsign	N0SZ
Owner Acronym	RMH
Owner Name	
Grid Square	
Telnet Port	8010
FBB Port	8011
HTTP Port	8008
AXIP Port	10093
AXIP AutoAdd	Yes
WinLink RMS	

<Set> <Finish>

Owner Name 2

File Edit View Search Terminal Help

AC0KQ bpq-config version 1.0

Owner Name

Enter Owner Name e.g. Colorado Traffic Net, used in prompts

Rocky Mountain Ham Radio

<Ok>

<Cancel>

Grid Square 1

File Edit View Search Terminal Help

AC0KQ bpq-config version 1.0

Node Configuration

Set Parameter

Node Callsign	N0SZ	↑
Owner Acronym	RMH	█
Owner Name	Rocky Mountain Ham Radio	█
Grid Square		█
Telnet Port	8010	█
FBB Port	8011	█
HTTP Port	8008	█
AXIP Port	10093	█
AXIP AutoAdd	Yes	█
WinLink RMS		↓

<Set> <Finish>

Grid Square 2

File Edit View Search Terminal Help

AC0KQ bpq-config version 1.0

Grid Square

Enter Grid Square e.g. DM79gr

DM79hm

<Ok> <Cancel>

Winlink RMS 1

(notice that it skipped items with defaults)

File Edit View Search Terminal Help

AC0KQ bpq-config version 1.0

Node Configuration

Set Parameter

Node Callsign	N0SZ
Owner Acronym	RMH
Owner Name	Rocky Mountain Ham Radio
Grid Square	DM79hm
Telnet Port	8010
FBB Port	8011
HTTP Port	8008
AXIP Port	10093
AXIP AutoAdd	Yes
WinLink RMS	

<Set> <Finish>

Winlink RMS 2

File Edit View Search Terminal Help

AC0KQ bpq-config version 1.0

WinLink RMS

Enable access to WinLink

<Yes>

<No>

CMS Callsign 1

(CMS call and password added when WinLink is Yes)

File Edit View Search Terminal Help

AC0KQ bpq-config version 1.0

Node Configuration

Set Parameter

Owner Acronym	RMH
Owner Name	Rocky Mountain Ham Radio
Grid Square	DM79hm
Telnet Port	8010
FBB Port	8011
HTTP Port	8008
AXIP Port	10093
AXIP AutoAdd	Yes
WinLink RMS	Yes
CMS Callsign	

<Set> <Finish>

CMS Callsign 2

File Edit View Search Terminal Help

AC0KQ bpq-config version 1.0

CMS Callsign

Enter CMS Callsign used to access WinLink.

N0SZ

<Ok> <Cancel>

CMS Password 1

File Edit View Search Terminal Help

AC0KQ bpq-config version 1.0

Set Parameter		Node Configuration
Owner Name	Rocky Mountain Ham Radio	↑
Grid Square	DM79hm	
Telnet Port	8010	
FBB Port	8011	
HTTP Port	8008	
AXIP Port	10093	
AXIP AutoAdd	Yes	
WinLink RMS	Yes	
CMS Callsign	N0SZ	
CMS Password		↓

<Set> <Finish>

CMS Password 2

File Edit View Search Terminal Help

AC0KQ bpq-config version 1.0

CMS Password

Enter CMS Password used to access WinLink.

BlahBlahBlah

<Ok>

<Cancel>

Chat Server 1

File Edit View Search Terminal Help

AC0KQ bpq-config version 1.0

Node Configuration

Set Parameter

Grid Square	DM79hm	↑ ↓
Telnet Port	8010	
FBB Port	8011	
HTTP Port	8008	
AXIP Port	10093	
AXIP AutoAdd	Yes	
WinLink RMS	Yes	
CMS Callsign	N0SZ	
CMS Password	BlahBlahBlah	
Chat Server		

<Set> <Finish>

Chat Server 2

File Edit View Search Terminal Help

AC0KQ bpq-config version 1.0

Chat Server

Enable Chat Server

<Yes>

<No>

APRS iGate 1

File Edit View Search Terminal Help

AC0KQ bpq-config version 1.0

Node Configuration

Set Parameter

Telnet Port	8010
FBB Port	8011
HTTP Port	8008
AXIP Port	10093
AXIP AutoAdd	Yes
WinLink RMS	Yes
CMS Callsign	N0SZ
CMS Password	BlahBlahBlah
Chat Server	No
APRS iGate	

<Set> <Finish>

APRS iGate 2

File Edit View Search Terminal Help

AC0KQ bpq-config version 1.0

APRS iGate

Enable APRS iGate

<Yes> **<No>**

Finish Node Configuration

File Edit View Search Terminal Help

AC0KQ bpq-config version 1.0

Node Configuration

Set Parameter

Node Callsign	N0SZ
Owner Acronym	RMH
Owner Name	Rocky Mountain Ham Radio
Grid Square	DM79hm
Telnet Port	8010
FBB Port	8011
HTTP Port	8008
AXIP Port	10093
AXIP AutoAdd	Yes
WinLink RMS	Yes

<Set> **<Finish>**

Configure Port

File Edit View Search Terminal Help

AC0KQ bpq-config version 1.0

Configuration Steps

Select next step

- 1 Node Configuration
- 2 Port configuration**
- 3 Telnet users
- 4 AXIP Node Maps
- 5 Write Configuration

<Select>

<Finish>

Add Port

File Edit View Search Terminal Help

AC0KQ bpq-config version 1.0

Port Configuration
Select port to

- 1 Add port**
- 2 Delete port

<Select> <Finish>

Port Type 1

File Edit View Search Terminal Help

AC0KQ bpq-config version 1.0

Set Parameter		Configure port
	Type	
	Device Type	
	Device Number	
	Frequency	
	Digipeat	Yes
	Power	
	Height	
	Gain	
<Set>		<Finish>

Port Type 2

File Edit View Search Terminal Help

AC0KQ bpq-config version 1.0

		Type
of port		
<input checked="" type="checkbox"/>	Packet	
<input type="checkbox"/>	APRS	
<input type="checkbox"/>	APRS rx only	
<Select>		<Cancel>

Device Type 1

File Edit View Search Terminal Help

AC0KQ bpq-config version 1.0

Configure port	
Set Parameter	
Type	Packet
Device Type	
Device Number	
Frequency	
Digipeat	Yes
Power	
Height	
Gain	
<Set>	<Finish>

Device Type 2

(Devices description is board specific)

File Edit View Search Terminal Help

AC0KQ bpq-config version 1.0

Device Type

There is only one serial port numbered 0
For multiple devices the I2C bus must be used
I2C bus addresses are in decimal

- Serial
- I2C

<Select>

<Cancel>

Device Number 1

File Edit View Search Terminal Help

AC0KQ bpq-config version 1.0

Configure port	
Set Parameter	
Type	Packet
Device Type	Serial
Device Number	
Frequency	
Digipeat	Yes
Power	
Height	
Gain	
<Set>	<Finish>

Device Number 2

File Edit View Search Terminal Help

AC0KQ bpq-config version 1.0

Device Number

Enter Device Number

There is only one serial port numbered 0

For multiple devices the I2C bus must be used

I2C bus addresses are in decimal

0

<Ok>

<Cancel>

Frequency 1

File Edit View Search Terminal Help

AC0KQ bpq-config version 1.0

Configure port	
Set Parameter	
Type	Packet
Device Type	Serial
Device Number	0
Frequency	
Digipeat	Yes
Power	
Height	
Gain	
<Set>	<Finish>

Frequency 2

File Edit View Search Terminal Help

AC0KQ bpq-config version 1.0

Frequency

Enter Frequency kHz e.g. 145050

145050

<Ok> <Cancel>

Transmit Power 1

(Used for WinLink reporting)

File Edit View Search Terminal Help

AC0KQ bpq-config version 1.0

Configure port

Set Parameter

Type	Packet
Device Type	Serial
Device Number	0
Frequency	145050
Digipeat	Yes
Power	
Height	
Gain	

<Set> <Finish>

Transmit Power 2

File Edit View Search Terminal Help

AC0KQ bpq-config version 1.0

Power

Enter Power Transmitter power in watts

<Ok> <Cancel>

Antenna Height 1

(Used for WinLink reporting)

File Edit View Search Terminal Help

AC0KQ bpq-config version 1.0

Configure port

Set Parameter

Type	Packet
Device Type	Serial
Device Number	0
Frequency	145050
Digipeat	Yes
Power	40
Height	
Gain	

<Set> <Finish>

Antenna Height 2

File Edit View Search Terminal Help

AC0KQ bpq-config version 1.0

Height

Enter Height Antenna height in feet

35

<Ok> <Cancel>

Antenna Gain 1

(Used for WinLink reporting)

File Edit View Search Terminal Help

AC0KQ bpq-config version 1.0

Configure port

Set Parameter

Type	Packet
Device Type	Serial
Device Number	0
Frequency	145050
Digipeat	Yes
Power	40
Height	35
Gain	

<Set> <Finish>

Antenna Gain 2

File Edit View Search Terminal Help

AC0KQ bpq-config version 1.0

Gain	
Enter Gain Antenna gain in dB	
<input type="text" value="6"/>	
<input type="button" value="Ok"/>	<input type="button" value="Cancel"/>

Finish Port Configuration

File Edit View Search Terminal Help

AC0KQ bpq-config version 1.0

Configure port

Set Parameter

Type	Packet
Device Type	Serial
Device Number	0
Frequency	145050
Digipeat	Yes
Power	40
Height	35
Gain	6

<Set> **<Finish>**

Finish Adding Ports

File Edit View Search Terminal Help

AC0KQ bpq-config version 1.0

Port Configuration
Select port to

- 1 Add port
- 2 Delete port
- 3 Port 1**

<Select> **<Finish>**

Add Telnet (IP) Users

(You must have at least one)

File Edit View Search Terminal Help

AC0KQ bpq-config version 1.0

Configuration Steps

Select next step

- 1 Node Configuration
- 2 Port configuration
- 3 Telnet users**
- 4 AXIP Node Maps
- 5 Write Configuration

<Select>

<Finish>

Add new Telnet user

File Edit View Search Terminal Help

AC0KQ bpq-config version 1.0

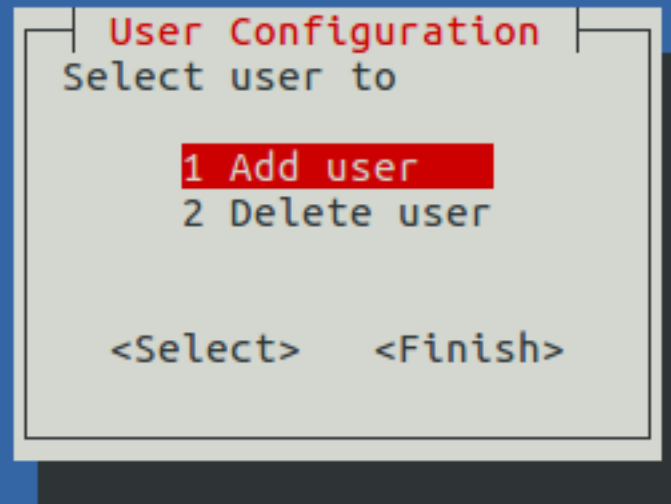

User Name 1

File Edit View Search Terminal Help

AC0KQ bpq-config version 1.0

Configure user	
Set Parameter	
	Username
	Password
	Callsign
	Application
	SysOp
<Set>	<Finish>

User Name 2

File Edit View Search Terminal Help

AC0KQ bpq-config version 1.0

Username

Enter Username e.g. willem

willem

<Ok>

<Cancel>

Password 1

File Edit View Search Terminal Help

AC0KQ bpq-config version 1.0

Configure user	
Set Parameter	
Username	willem
Password	
Callsign	
Application	
SysOp	
<Set>	<Finish>

Password 2

File Edit View Search Terminal Help

AC0KQ bpq-config version 1.0

Enter Password e.g. XyZ123

abc123

<Ok> <Cancel>

Callsign 1

File Edit View Search Terminal Help

AC0KQ bpq-config version 1.0

Configure user	
Set Parameter	
Username	willem
Password	abc123
Callsign	
Application	SysOp
<Set>	<Finish>

Callsign 2

File Edit View Search Terminal Help

AC0KQ bpq-config version 1.0

Enter Callsign Callsign

AC0KQ

<Ok> <Cancel>

Application 1

File Edit View Search Terminal Help

AC0KQ bpq-config version 1.0

Configure user	
Set Parameter	
Username	willem
Password	abc123
Callsign	AC0KQ
Application	
SysOp	
<Set>	<Finish>

Application 2

File Edit View Search Terminal Help

AC0KQ bpq-config version 1.0

Application

Select application to connect to

- NODE
- BBS

<Select> <Cancel>

System Operator 1

File Edit View Search Terminal Help

AC0KQ bpq-config version 1.0

Configure user	
Set Parameter	
Username	willem
Password	abc123
Callsign	AC0KQ
Application	NODE
	SysOp
<Set>	<Finish>

System Operator 2

File Edit View Search Terminal Help

AC0KQ bpq-config version 1.0

SysOp

System operator priviliges

<Yes>

<No>

Finish User Configuration

File Edit View Search Terminal Help

AC0KQ bpq-config version 1.0

Configure user	
Set Parameter	
Username	willem
Password	abc123
Callsign	AC0KQ
Application	NODE
SysOp	Yes
<Set>	<Finish>

Add Another User

File Edit View Search Terminal Help

AC0KQ bpq-config version 1.0

User Configuration
Select user to

- 1 Add user
- 2 Delete user
- 3 willem

<Select> <Finish>

Finish adding second user

File Edit View Search Terminal Help

AC0KQ bpq-config version 1.0

Configure user	
Set Parameter	
Username	john
Password	xyz123
Callsign	W0VG
Application	NODE
SysOp	Yes
<Set>	<Finish>

Finish adding Telnet Users

File Edit View Search Terminal Help

AC0KQ bpq-config version 1.0

User Configuration
Select user to

- 1 Add user
- 2 Delete user
- 3 john
- 4 willem

<Select> **<Finish>**

Configure AXIP Node Maps

File Edit View Search Terminal Help

AC0KQ bpq-config version 1.0

Configuration Steps

Select next step

- 1 Node Configuration
- 2 Port configuration
- 3 Telnet users
- 4 AXIP Node Maps**
- 5 Write Configuration

<Select>

<Finish>

Add new AXIP map

File Edit View Search Terminal Help

AC0KQ bpq-config version 1.0

Map Configuration
Select map to

- 1 Add map**
- 2 Delete map

<Select> <Finish>

Callsign 1

File Edit View Search Terminal Help

AC0KQ bpq-config version 1.0

Configure map	
Set Parameter	
	Callsign
	Address
	Port 10093
<Set>	<Finish>

Callsign 2

File Edit View Search Terminal Help

AC0KQ bpq-config version 1.0

Callsign

Enter Callsign Node callsign (SSID optional)

K0NTS-1

<Ok> <Cancel>

AX IP Address 1

File Edit View Search Terminal Help

AC0KQ bpq-config version 1.0

Configure map	
Set Parameter	
Callsign	K0NTS-1
Address	
Port	10093
<Set>	<Finish>

AX IP Address 2

File Edit View Search Terminal Help

AC0KQ bpq-config version 1.0

Address

Enter Address IP address or DNS address

ctnpi.ac0kq.rmham

<Ok> <Cancel>

Done Adding AXIP Map

File Edit View Search Terminal Help

AC0KQ bpq-config version 1.0

Configure map	
Set Parameter	
Callsign	K0NTS-1
Address	ctnpi.ac0kq.rmham
Port	10093
<Set>	<Finish>

Finish adding AXIP maps

File Edit View Search Terminal Help

AC0KQ bpq-config version 1.0

Map Configuration

Select map to

- 1 Add map
- 2 Delete map
- 3 K0NTS-1

<Select>

<Finish>

Write BPQ Configuration

File Edit View Search Terminal Help

AC0KQ bpq-config version 1.0

Configuration Steps

Select next step

- 1 Node Configuration
- 2 Port configuration
- 3 Telnet users
- 4 AXIP Node Maps
- 5 Write Configuration**

<Select>

<Finish>

Files Written by bpq-config

File Edit View Search Terminal Help

AC0KQ bpq-config version 1.0

bpq-config save

Wrote bpq32.cfg
Write linmail.cfg
Wrote BPQBBSUsers.dat
Wrote /lib/systemd/system/bpq.service
Wrote /etc/minicom/minirc.bpq
Wrote minicombpq
Wrote /usr/local/bin/bterm

<Ok>

Done with Configuration

File Edit View Search Terminal Help

AC0KQ bpq-config version 1.0

Configuration Steps

Select next step

- 1 Node Configuration
- 2 Port configuration
- 3 Telnet users
- 4 AXIP Node Maps
- 5 Write Configuration

<Select>

<Finish>

Start BPQ

File Edit View Search Terminal Help

AC0KQ bpq-config version 1.0

Installation Steps

Select next step

- 1 Download BPQ
- 2 Configure BPQ
- 3 Start BPQ**
- 4 Enable BPQ start at boot
- 5 About bpq-config

<Select>

<Finish>

Options after Starting BPQ

File Edit View Search Terminal Help

AC0KQ bpq-config version 1.0

Installation Steps

Select next step

- 1 Download BPQ
- 2 Configure BPQ
- 3 Restart BPQ
- 4 Stop BPQ
- 5 Enable BPQ start at boot
- 6 About bpq-config

<Select>

<Finish>

Browse to BPQ node port 8008

(if you configured a different port, use it instead)



BPQ Ports

BPQ32 Node N0SZ-7

[Routes](#) [Nodes](#) [Ports](#) [Links](#) [Users](#) [Stats](#) [Terminal](#) [Driver Windows](#) [Stream Status](#) [Mail Server Pages](#) [SYSOP Signin](#) [Edit Config](#)

Ports

Port	Driver	ID	Beacons
1	ASYNC	145.050 MHz 1200 bps	Beacons
2	TELNET	Telnet Server	
3	BPQAXIP	AX/IP/UDP	Beacons

Click *Mail Server Pages*

BPQ32 Mail Server / x

192.168.11.114:8008/Mail/Header

BPQ32 Mail Server N0SZ-7 Access

Please enter Callsign and Password to access the BBS

User

Password

BBS Configuration

(bpq-config set most of these in linmail.cfg)

bpq Main Configuration x

192.168.11.114:8008/Mail/Conf?M000077442E50

BPQ32 BBS N0SZ

[Status](#) [Configuration](#) [Users](#) [Messages](#) [Forwarding](#) [Welcome Msgs & Prompts](#) [Housekeeping](#) [WP Update](#) [Node Menu](#)

Main Configuration

BBS Params

BBS Call SYSOP Call

H Route Redirect msgs to BBS Call to SYSOP Call

BBS APPL No Streams

Send System Msgs to SYSOP Call
 Refuse Bulls
 Enable FBB UI System
Send Mail For Beacons every Minutes

Don't Hold Messages From New Users
 Don't Request Name
 Don't Request Home BBS
 Allow users to kill T messages
 Forward Messages to BBS Call

POP3 Port SMTP Port NTPPort Enable Remote Access
AMPR Address Send AMPR Mail to AMPR host

TSP Params

BBS Users

(bpq-config added RMS and telnet users)

BPQ32 BBS N0SZ

[Status](#) [Configuration](#) [Users](#) [Messages](#) [Forwarding](#) [Welcome Msgs & Prompts](#) [Housekeeping](#) [WP Update](#) [Node Menu](#)

[AC0KQ](#)
[N0SZ](#)
[RMS](#)
[W0VG](#)

Update User AC0KQ

<input type="checkbox"/> BBS	<input type="checkbox"/> Permit Email
<input type="checkbox"/> PMS	<input type="checkbox"/> RMS Express User
<input checked="" type="checkbox"/> SYSOP	<input type="checkbox"/> Poll RMS
<input type="checkbox"/> Expert	For SSID's <input type="text"/> <input type="text"/> <input type="text"/> <input type="text"/>
<input type="checkbox"/> Excluded	<input type="checkbox"/> Hold Messages
<input type="checkbox"/> Include SYSOP msgs in LM	<input type="checkbox"/> Don't add @winlink.org
<input checked="" type="checkbox"/> Allow Sending Bulls	<input type="checkbox"/> NTS MPS

Connects In 0 Msgs in 0 Rejects In 0
Connects Out 0 Msgs Out 0 Rejects Out 0
Bytes In 0 Last Connect 01-Jan 00:00Z
Bytes Out 0 Last Listed 0

Name
Password CMS Pass
QTH ZIP
Home BBS

User RMS is a WinLink2000

BPQ32 BBS N0SZ

[Status](#) [Configuration](#) [Users](#) [Messages](#) [Forwarding](#) [Welcome Msgs & Prompts](#) [Housekeeping](#) [WP Update](#) [Node Menu](#)

[AC0KQ](#)
[N0SZ](#)
[RMS](#)
[W0VG](#)

Update User RMS

BBS
 PMS
 SYSOP
 Expert
 Excluded
 Include SYSOP msgs in LM
 Allow Sending Bulls

Permit Email
 RMS Express User
 Poll RMS
For SSID's
 Hold Messages
 Don't add @winlink.org
 NTS MPS

Connects In 0 Msgs in 0 Rejects In 0
Connects Out 0 Msgs Out 0 Rejects Out 0
Bytes In 0 Last Connect 01-Jan 00:00Z
Bytes Out 0 Last Listed 0

Name
Password CMS Pass
QTH ZIP
Home BBS

Forwarding to Winlink is Enabled

BPQ32 BBS N0SZ

[Status](#) [Configuration](#) [Users](#) [Messages](#) **Forwarding** [Welcome Msgs & Prompts](#) [Housekeeping](#) [WP Update](#) [Node Menu](#)

Max size to Send: 100000
Max Size to Receive: 100000
Max age for Bulls: 60
Warn if no route for P or T:
Use Local Time:
Aliases:

[N0SZ](#)
[RMS](#)

Forwarding Config for RMS - 0 Messages Queued

TO	AT	TIMES	Connect Script
RMS			RMS

Hierarchical Routes (Flood Bulls) HR (Personals and Directed Bulls)

BBS HA

Enable Forwarding	<input checked="" type="checkbox"/>	Interval	3600	(Secs)	
Request Reverse	<input checked="" type="checkbox"/>	Interval	3600	(Secs)	
Send new messages without waiting for poll timer	<input checked="" type="checkbox"/>				
FBB Max Block	10000	Send Personal Mail Only	<input type="checkbox"/>		
Allow Binary	<input checked="" type="checkbox"/>	Use B1 Protocol	<input checked="" type="checkbox"/>	Use B2 Protocol	<input checked="" type="checkbox"/>
Send ctrl/Z instead of /ex in text mode forwarding	<input type="checkbox"/>				

Housekeeping

BPQ32 BBS N0SZ

[Status](#) [Configuration](#) [Users](#) [Messages](#) [Forwarding](#) [Welcome Msgs & Prompts](#) [Housekeeping](#) [WP Update](#) [Node Menu](#)

Housekeeping

Parameters

Maintenance Time (UTC)

Max Message Number

BID Lifetime (Days)

Log File Lifetime (days)

Delete Inactive Users (days)

Delete Messages and logs to recycle bin

Send Non-delivery Notifications for P and T messages

Supress Mailing of Housekeeping Result

Lifetimes

Personals		Bulletins		NTS	
Read	<input type="text" value="30"/>	Forwarded	<input type="text" value="30"/>	Delivered	<input type="text" value="30"/>
Unread	<input type="text" value="30"/>	Unforwarded	<input type="text" value="999"/>	Forwarded	<input type="text" value="30"/>
Forwarded	<input type="text" value="30"/>			Unforwarded	<input type="text" value="999"/>
Unforwarded	<input type="text" value="999"/>				

The following boxes allow you to specify different values for different Bulletin origins and destinations. Normally these apply to Sent Messages. To apply to unsent, check box below.

Specify Call, Lifetime...eg ALL, 10

From	To	At
<input type="text"/>	<input type="text"/>	<input type="text"/>

Apply Overrides to unsent Bulls

Connect out via RF

```
willem@bashful: ~  
File Edit View Search Terminal Help  
willem@bashful:~$ telnet 192.168.11.114 8010  
Trying 192.168.11.114...  
Connected to 192.168.11.114.  
Escape character is '^]'.  
user:chris  
password:  
  
AID2 BPQ32 Telnet Server  
Enter ? for list of commands  
  
c 1 K0NTS-1  
N0SZ} Connected to K0NTS-1  
[BPQ-6.0.12.35-IHJM$]  
Hello KD0ZYF. Latest Message is 2506, Last listed is 2506  
CTN BBS>  
b  
73 de CTN BBS  
*** Disconnected from Stream 1  
Connection closed by foreign host.  
willem@bashful:~$
```

Connect in via RF (as AC0KQ)

```
willem@bashful: ~  
File Edit View Search Terminal Help  
  
cmd c N0SZ  
cmd:*** CONNECTED to N0SZ  
Welcome to the Aid Station 2 BPQ32 Node.  
N0SZ> BBS CONNECT BYE INFO NODES ROUTES PORTS USERS MHEARD  
info  
N0SZ} This is the BPQ32 Node for the Aid Station 2.  
Sysop KD0ZYF.  
Traffic left on this node will be forwarded  
using the National Traffic System.  
Type BBS to connect to the BBS.  
ports  
N0SZ} Ports  
 1 145.030 MHz 1200 bps  
 2 Telnet Server  
 3 AX/IP/UDP  
bbs  
N0SZ} Connected to BBS  
[BPQ-6.0.12.35-IHJM$]  
Hello AC0KQ. Latest Message is 2, Last listed is 2  
de N0SZ>  
b  
*** DISCONNECTED  
cmd: 
```

Connect via RF to WinLink

```
willem@bashful: ~  
File Edit View Search Terminal Help  
cmd: c N0SZ-10  
cmd: *** CONNECTED to N0SZ-10  
Trying brentwood.winlink.org  
*** AC0KQ Connected to CMS  
[WL2K-3.2-B2FWIHJM$]  
;PQ: 72781840  
Brentwood CMS via N0SZ >  
lm  
Login [246]:  
Brentwood CMS via N0SZ >  
CR 067MRW  
Hello AC0KQ  
Brentwood CMS via N0SZ >  
lm  
2884_K0TER 2016/05/07 01:27 676 K0TER@winlink.org QTC 2  
3KYUXDSAP727 2016/05/02 15:51 889 K6HTN@winlink.org Re: QTC 1 K6HTN  
2882_K0TER 2016/05/04 16:40 1180 K0TER@winlink.org QTC 4  
6AQ9DQG3C59D 2016/05/04 18:30 1295 WA3QLW@winlink.org QTC 8  
2883_K0TER 2016/05/05 18:35 2281 K0TER@winlink.org QTC 7  
2868_K0TER 2016/05/03 17:26 2803 K0TER@winlink.org QTC 9  
2886_K0TER 2016/05/07 21:52 3103 K0TER@winlink.org QTC 10  
Brentwood CMS via N0SZ >  
b  
Disconnecting...  
*** DISCONNECTED  
cmd: 
```

BBS Messages

Browser window: Edit Messages - Chromium
URL: ctnpi:8080/Mail/Msgs?M000039592D06

BPQ32 BBS K0NTS

[Status](#) [Configuration](#) [Users](#) [Messages](#) [Forwarding](#) [Welcome Msgs & Prompts](#) [Housekeeping](#) [WP Update](#) [Node Menu](#)

Filter

From:
To:
Via:

- [2504](#)
- [2503](#)
- [2498](#)
- [2497](#)
- [2494](#)
- [2493](#)
- [2492](#)
- [2491](#)
- [2486](#)
- [2485](#)
- [2483](#)
- [2482](#)
- [2481](#)

Message 2555

From	AC0KQ	Sent	08-May 21:40Z	Type	P ▼
To	K0TER	Received	08-May 21:40Z	Status	F ▼
BID	2555 K0NTS	Last Changed	08-May 21:41Z	Size	210

VIA:

Title: QTC 1 PHILA PA 215 276

Green = Sent, Yellow = Queued

K0NTS	RMS						
-------	-----	--	--	--	--	--	--

General BBS Users

Chromium Edit Users - Chromium

ctnpi:8080/Mail/Users?M000039592D06

BPQ32 BBS K0NTS

[Status](#) [Configuration](#) [Users](#) [Messages](#) [Forwarding](#) [Welcome Msgs & Prompts](#) [Housekeeping](#) [WP Update](#) [Node Menu](#)

[KB5YZB](#)
[KC0JPO](#)
[KC0ONP](#)
[KC0WDN](#)
[KC4YLV](#)
[KD0CIM](#)
[KD0CRX](#)
[KD0DPX](#)
[KD0FDS](#)
[KD0GBX](#)
[KD0KVJ](#)
[KD0MSP](#)
[KD0RML](#)
[KD0RNF](#)
[KD0RPH](#)
[KD0SOO](#)
[KD0SQA](#)
[KD0WHB](#)
[KD0WZK](#)
[KD0YGO](#)
[KD0ZYF](#)
[KD8BQN](#)
[KE0CRD](#)

Update User KD0ZYF

<input type="checkbox"/> BBS	<input type="checkbox"/> Permit Email
<input type="checkbox"/> PMS	<input type="checkbox"/> RMS Express User
<input type="checkbox"/> SYSOP	<input type="checkbox"/> Poll RMS
<input type="checkbox"/> Expert	For SSID's <input type="checkbox"/> <input type="checkbox"/> <input type="checkbox"/> <input type="checkbox"/>
<input type="checkbox"/> Excluded	<input type="checkbox"/> Hold Messages
<input type="checkbox"/> Include SYSOP msgs in LM	<input type="checkbox"/> Don't add @winlink.org
<input checked="" type="checkbox"/> Allow Sending Bulls	<input type="checkbox"/> NTS MPS

Connects In 6 Msgs in 0 Rejects In 0
Connects Out 0 Msgs Out 0 Rejects Out 0
Bytes In 0 Last Connect 08-May 20:12Z
Bytes Out 0 Last Listed 2507

Name
Password CMS Pass
QTH ZIP
Home BBS

WinLink User Download

Edit Users - Chromium

Edit Users

ctnpi:8080/Mail/Users?M000039592D06

BPQ32 BBS K0NTS

[Status](#) [Configuration](#) [Users](#) [Messages](#) [Forwarding](#) [Welcome Msgs & Prompts](#) [Housekeeping](#) [WP Update](#) [Node Menu](#)

[AA0QC](#)
[AC0KQ](#)
[AC0TG](#)
[AC0VC](#)
[AC9D](#)
[AD0RX](#)
[AI8Z](#)
[K0KAI](#)
[K0LAI](#)
[K0MEL](#)
[K0NTS](#)
[K0SCH](#)
[K0XK](#)
[K6DHN](#)
[K6XCQ](#)
[KA0BSA](#)
[KB0BSA](#)
[KB1SGJ](#)
[KB5YZB](#)
[KC0JPO](#)
[KC0ONP](#)
[KC0WDN](#)
[KC4YLV](#)
[K000M](#)

Update User AC0KQ

BBS Permit Email
 PMS RMS Express User
 SYSOP Poll RMS
 Expert For SSID's
 Excluded Hold Messages
 Include SYSOP msgs in LM Don't add @winlink.org
 Allow Sending Bulls NTS MPS

Connects In 9 Msgs in 42 Rejects In 0
Connects Out 0 Msgs Out 1 Rejects Out 0
Bytes In 10416 Last Connect 08-May 21:39Z
Bytes Out 533 Last Listed 2514

Name
Password
QTH ZIP
Home BBS

Forwarding BBS

Edit Users - Chromium

Edit Users

192.168.11.114:8080/Mail/Users?M0000399D835D

BPQ32 BBS N0SZ

[Status](#) [Configuration](#) [Users](#) [Messages](#) [Forwarding](#) [Welcome Msgs & Prompts](#) [Housekeeping](#) [WP Update](#) [Node Menu](#)

[AC0KO](#)
[KB1SGJ](#)
[KB5YZB](#)
[KD0ZYF](#)
[N0SZ](#)
[RMS](#)

Update User KB1SGJ

BBS Permit Email
 PMS RMS Express User
 SYSOP Poll RMS
 Expert For SSID's
 Excluded Hold Messages
 Include SYSOP msgs in LM Don't add @winlink.org
 Allow Sending Bulls NTS MPS

Connects In 0 Msgs in 0 Rejects In 0
Connects Out 0 Msgs Out 0 Rejects Out 0
Bytes In 0 Last Connect 01-Jan 00:00Z
Bytes Out 0 Last Listed 0

Name
Password CMS Pass
QTH ZIP
Home BBS

Forwarded Users

Edit Forwarding - Chromium

Edit Forwarding

192.168.11.114:8080/Mail/FWD?M0000399D835D

BPQ32 BBS N0SZ

[Status](#) [Configuration](#) [Users](#) [Messages](#) [Forwarding](#) [Welcome Msgs & Prompts](#) [Housekeeping](#) [WP Update](#) [Node Menu](#)

Max size to Send

Max Size to Receive

Max age for Bulls

Warn if no route for P or T

Use Local Time

Aliases

Forwarding Config for KB1SGJ - 0 Messages Queued

TO	AT	TIMES	Connect Script
<input type="text" value="KB1SGJ
KD0LDR"/>	<input type="text"/>	<input type="text" value="0000-1000"/>	<input type="text" value="C 1 KB1SGJ-1"/>

Hierarchical Routes (Flood Bulls) HR (Personals and Directed Bulls)

RBS HA

Enable Forwarding Interval (Secs)
 Request Reverse Interval (Secs)
 Send new messages without waiting for poll timer
FBB Max Block Send Personal Mail Only
 Allow Binary Use B1 Protocol Use B2 Protocol
 Send ctrl/Z instead of /ex in text mode forwarding

RF > N0SZ & AXIP > K0NTS-1

```
willem@bashful: ~  
File Edit View Search Terminal Help  
  
cmd:c N0SZ  
cmd:*** CONNECTED to N0SZ  
Welcome to the Aid Station 2 BPQ32 Node.  
N0SZ> BBS CONNECT BYE INFO NODES ROUTES PORTS USERS MHEARD  
ports  
N0SZ} Ports  
 1 145.030 MHz 1200 bps  
 2 Telnet Server  
 3 AX/IP/UDP  
c 3 K0NTS-1  
N0SZ} Connected to K0NTS-1  
[BPQ-6.0.12.35-IHJM$]  
CTN BBS>  
l  
No New Messages  
CTN BBS>  
b  
73 de CTN BBS  
*** DISCONNECTED  
cmd:  
cmd:  
cmd:  
cmd:
```

Setting up an iGate

- **This iGate setup is on a BeagleBone Black**
 - The only difference with an rPi is the serial port names in the Port section
- **The Node setup is the same as what was done previously**
 - Some but not all the parameters are relevant
- **Ports are mapped as Packet or APRS in port configuration**
 - You can have both Packet and APRS ports on the same BPQ node

Node Configuration

(Note that Winlink RMS and Chat is NO)

File Edit View Search Terminal Help

AC0KQ bpq-config version 1.0

Node Configuration

Set Parameter

Owner Name	Rocky Mountain Ham Radio	↑
Grid Square	DM79hm	
Telnet Port	8010	
FBB Port	8011	
HTTP Port	8008	
AXIP Port	10093	
AXIP AutoAdd	Yes	
WinLink RMS	No	
Chat Server	No	
APRS iGate		↓

<Set> <Finish>

Enable iGate

File Edit View Search Terminal Help

AC0KQ bpq-config version 1.0

APRS iGate

Enable APRS iGate

<Yes>

<No>

iGate APRS SSID 1

(note APRS specific new items)

File Edit View Search Terminal Help

AC0KQ bpq-config version 1.0

Node Configuration

Set Parameter

Grid Square	DM79hm	↑
Telnet Port	8010	█
FBB Port	8011	█
HTTP Port	8008	█
AXIP Port	10093	█
AXIP AutoAdd	Yes	█
WinLink RMS	No	█
Chat Server	No	█
APRS iGate	Yes	█
APRS SSID		↓

<Set> <Finish>

iGate APRS SSID 2

File Edit View Search Terminal Help

AC0KQ bpq-config version 1.0

APRS SSID

Enter APRS SSID (e.g. 11])

14

<Ok> <Cancel>

APRS Symbol Set 1

(used to set symbol on aprs.fi)

File Edit View Search Terminal Help

AC0KQ bpq-config version 1.0

Node Configuration

Set Parameter

Telnet Port	8010
FBB Port	8011
HTTP Port	8008
AXIP Port	10093
AXIP AutoAdd	Yes
WinLink RMS	No
Chat Server	No
APRS iGate	Yes
APRS SSID	14
APRS Symset	

<Set> <Finish>

APRS Symbol Set 2

File Edit View Search Terminal Help

AC0KQ bpq-config version 1.0

APRS Symset

Enter APRS Symset Single character or digit (e.g. B)

B

<Ok>

<Cancel>

APRS Symbol 1

(used to set symbol on aprs.fi)

File Edit View Search Terminal Help

AC0KQ bpq-config version 1.0

Node Configuration

Set Parameter

FBB Port	8011	↑ ↓
HTTP Port	8008	
AXIP Port	10093	
AXIP AutoAdd	Yes	
WinLink RMS	No	
Chat Server	No	
APRS iGate	Yes	
APRS SSID	14	
APRS Symset	B	
APRS Symbol		

<Set> <Finish>

APRS Symbol 2

File Edit View Search Terminal Help

AC0KQ bpq-config version 1.0

APRS Symbol

Enter APRS Symbol Single character or digit (e.g. a)

a

<Ok>

<Cancel>

APRS Status Message 1

(used when beaconing)

File Edit View Search Terminal Help

AC0KQ bpq-config version 1.0

Node Configuration	
Set Parameter	
HTTP Port	8008
AXIP Port	10093
AXIP AutoAdd	Yes
WinLink RMS	No
Chat Server	No
APRS iGate	Yes
APRS SSID	14
APRS Symset	B
APRS Symbol	a
Status Message	

<Set> <Finish>

APRS Status Message 2

File Edit View Search Terminal Help

AC0KQ bpq-config version 1.0

Status Message

Enter Status Message (used in broadcast)

RMHAM iGate Conifer

<Ok>

<Cancel>

iGate Latitude 1

File Edit View Search Terminal Help

AC0KQ bpq-config version 1.0

Node Configuration

Set Parameter

AXIP Port	10093	↑ ↓
AXIP AutoAdd	Yes	
WinLink RMS	No	
Chat Server	No	
APRS iGate	Yes	
APRS SSID	14	
APRS Symset	B	
APRS Symbol	a	
Status Message	RMHAM iGate Conifer	
Latitude		

<Set> <Finish>

iGate Latitude 2

File Edit View Search Terminal Help

AC0KQ bpq-config version 1.0

Latitude

Enter Latitude (ddmm.mm[NS])

3931.04N

<Ok> <Cancel>

iGate Longitude 1

File Edit View Search Terminal Help

AC0KQ bpq-config version 1.0

Node Configuration

Set Parameter

AXIP AutoAdd	Yes	↑ ↓
WinLink RMS	No	
Chat Server	No	
APRS iGate	Yes	
APRS SSID	14	
APRS Symset	B	
APRS Symbol	a	
Status Message	RMHAM iGate Conifer	
Latitude	3931.04N	
Longitude		

<Set> <Finish>

iGate Longitude 2

File Edit View Search Terminal Help

AC0KQ bpq-config version 1.0

Longitude

Enter Longitude (dddmm.mm[EW])

10521.00W

<Ok> <Cancel>

APRS2 Gateway 1

(where to send APRS reports)

File Edit View Search Terminal Help

AC0KQ bpq-config version 1.0

Node Configuration

Set Parameter

WinLink RMS	No	↑ ↓
Chat Server	No	
APRS iGate	Yes	
APRS SSID	14	
APRS Symset	B	
APRS Symbol	a	
Status Message	RMHAM iGate Conifer	
Latitude	3931.04N	
Longitude	10521.00W	
APRS2		

<Set> <Finish>

APRS2 Gateway 2

(bpq-config generates password automatically)

File Edit View Search Terminal Help

AC0KQ bpq-config version 1.0

APRS2

Select server by region

- (*) noam
- () soam
- () euro
- () asia
- () aunz

Finish iGate Node Configuration

File Edit View Search Terminal Help

AC0KQ bpq-config version 1.0

Node Configuration

Set Parameter

Node Callsign	N0SZ	↑
Owner Acronym	RMH	█
Owner Name	Rocky Mountain Ham Radio	█
Grid Square	DM79hm	█
Telnet Port	8010	█
FBB Port	8011	█
HTTP Port	8008	█
AXIP Port	10093	█
AXIP AutoAdd	Yes	█
WinLink RMS	No	↓

<Set> **<Finish>**

iGate Add Port Configuration

File Edit View Search Terminal Help

AC0KQ bpq-config version 1.0

Set Parameter		Configure port
		Type
		Device Type
		Device Number
		Frequency
		Digipeat Yes
		Power
		Height
		Gain
<Set>		<Finish>

Set Port Type to APRS

File Edit View Search Terminal Help

AC0KQ bpq-config version 1.0

	Type
of port	
<input type="checkbox"/> Packet	
<input checked="" type="checkbox"/> APRS	
<input type="checkbox"/> APRS rx only	
<input type="button" value="Select"/>	<input type="button" value="Cancel"/>

Set Serial Port

(Note that this is a Beaglebone so 4 ports)

File Edit View Search Terminal Help

AC0KQ bpq-config version 1.0

Device Type

Serial ports are numbered 1, 2, 4 or 5

Serial
 I2C

<Select>

<Cancel>

Select Serial Port Number

File Edit View Search Terminal Help

AC0KQ bpq-config version 1.0

Configure port	
Set Parameter	
Type	APRS
Device Type	Serial
Device Number	
Frequency	
Digipeat	Yes
Power	
Height	
Gain	
<Set>	<Finish>

Select Serial Port Number

File Edit View Search Terminal Help

AC0KQ bpq-config version 1.0

Device Number

Enter Device Number

Serial ports are numbered 1, 2, 4 or 5

1

<Ok>

<Cancel>

APRS Frequency 1

File Edit View Search Terminal Help

AC0KQ bpq-config version 1.0

Configure port	
Set Parameter	
Type	APRS
Device Type	Serial
Device Number	1
Frequency	
Digipeat	Yes
Power	
Height	
Gain	
<Set>	<Finish>

APRS Frequency 2

File Edit View Search Terminal Help

AC0KQ bpq-config version 1.0

Frequency

Enter Frequency kHz e.g. 145050

144390

<Ok> <Cancel>

Finish Port Configuration

File Edit View Search Terminal Help

AC0KQ bpq-config version 1.0

Configure port

Set Parameter

Type	APRS
Device Type	Serial
Device Number	1
Frequency	144390
Digipeat	Yes
Power	40
Height	50
Gain	6

<Set> **<Finish>**

Node Page Update

N0SZ's BPQ32 Web Server - Chromium

N0SZ's BPQ32 Web S x

192.168.11.114:8080/Node/CFGSave?N0000BF0D8620

BPQ32 Node N0SZ

[Routes](#) [Nodes](#) [Ports](#) [Links](#) [Users](#) [Stats](#) [Terminal](#) [Driver Windows](#) [Stream Status](#) [APRS Pages](#) [Mail Server Pages](#) [SYSOP Signin](#) [Edit Config](#)

APRS Main Page

N0SZ-14's BPQ32 APRS Web Server

All Stations

(This page will automatically refresh every five minutes)

The following is a list of all the stations heard in the past 120 minutes, both on RF and on the internet.

There are 21 callsigns in the list, click a callsign to get an information page for that station.

AC0VP-10	BVILLE	KB0USE	KC0D	KC0D-6	KC0WUV	KD0SQA-4	N0EB
N0LNE	N0SZ-14	N0SZ-2	N0WGM-3	N1GEP-1	N7GN-5	W0JAW	W0JRL-15
WA0GEH	WB5PJB-B	WD4IXD	WD4IXD-10	WQ8M-9			

APRS RF Stations

N0SZ-14's BPQ32 Web Server - Chromium

N0SZ-14's BPQ32 W x

192.168.11.114:8080/aprs/allrf.html

[Home](#)
[All Stations](#)
[RF Stations](#)
[All WX Stations](#)
[RF WX Stations](#)
[All Mobile Stations](#)
[RF Mobile Stations](#)
[All Objects](#)
[RF Objects](#)
[Information](#)
[Node Pages](#)

N0SZ-14's BPQ32 APRS Web Server

RF Stations

(This page will automatically refresh every five minutes)

The following is a list of all the stations heard on RF in the past 120 minutes.

'**' after a callsign means that it was heard via a digi

The list only includes callsigns heard on RF, direct or via digipeaters. It does not include callsigns heard on the internet, or heard as third-party RF traffic via IGATEs.

There are 8 callsigns in the list, click a callsign to get an information page for that station.

Callsign	Symbol	Location	Miles	Bearing	Last heard
KC0D	No. Digi	39°22.20'N 104°40.76'W	37.2	106	02:17:57
KC0D-6*	WX Station	39°18.13'N 104°41.32'W	38.3	113	02:20:18
KD0SQA-4*	Digi	39°40.14'N 104°55.46'W	25.0	65	02:16:58
N0EB	XAPRS	39°53.56'N 104°58.15'W	32.9	38	02:21:22
N0SZ-2*	Car	40°07.90'N 104°55.73'W	47.9	28	02:19:20
N0WGM-3*	WX Station	40°48.92'N 104°47.64'W	94.3	18	02:20:59
N1GEP-1*	Rover	39°40.36'N 104°45.90'W	32.9	71	02:18:02
N7GN-5*	WX Station	40°32.73'N 105°05.53'W	72.3	11	02:19:50

APRS Station Map

N0SZ-14's BPQ32 Web Server - Chromium

N0SZ-14's BPQ32 Web Server

192.168.11.114:8080/aprs/find.cgi?call=N0SZ-2

Home
All Stations
RF Stations
All WX Stations
RF WX Stations
All Mobile Stations
RF Mobile Stations
All Objects
RF Objects
Information
Node Pages

N0SZ-14's BPQ32 APRS Web Server

(This page will automatically refresh every five minutes)

Information about [N0SZ-2](#)

Click the callsign to look it up on qrz.com
Location: 40°07.90'N 104°55.73'W
The bearing from N0SZ-14 to N0SZ-2 is 028 degrees, the distance is 47.9 Miles

Last posit: TPPWYP,W0UPS-5,WIDE1,KC0D,WIDE2*

Status:
Last heard 00:05:11 ago



Map Satellite OSM MQ

Script FSVAQ
Map data ©2016 Google 5 km Terms of Use Report a map error

Report on aprs.fi

The screenshot shows the aprs.fi website interface within a Chromium browser window. The browser title is "Google Maps APRS - Chromium" and the address bar contains the URL: `aprs.fi/#!mt=roadmap&z=11&call=a%2FN0SZ-14&timerange=3600&tail=3600`. The main map area displays a satellite-style view of a region in Ontario, Canada, with a red diamond icon labeled "NOSZ-14" indicating the current position. A popup window for "NOSZ-14" is open, showing the following details:

- Call Sign:** NOSZ-14
- Center:** center
- Zoom:** zoom
- Info:** info
- Time Range:** 2015-09-26 16:16:56 - 2016-05-09 06:53:22
- Software:** BPQ32 Igate V 6.0.12.35
- Hardware:** RMHAM iGate
- Location:** [APBPQ1 via TCP/IP*, qAC, T2ONTARIO]
- Status:** being tracked
- Actions:** stop tracking, track in Street View

The right sidebar contains navigation and tracking options:

- aprs.fi · Login**
- Free Travel Maps** (Get Maps, Directions & Traffic Conditions With OnlineMapFinder!)
- Track callsign:** Clear (with a search input field)
- Address, city or Locator:** Clear (with a search input field)
- Show last:** 1 hour (with a "Show all" button)
- Track tail length:** 1 hour
- NOSZ-14** (with a red diamond icon and a menu icon)
- Updated:** 2016-05-09 06:53:22 (29m)
- Position:** 39°31.04' N 105°21.00' W
- Other SSIDs:** NOSZ-10, NOSZ-12, NOSZ-15, NOSZ-2, NOSZ-3, NOSZ-4, NOSZ-7, BBS
- Weather:** Wx: 43°F 84% 1003 mbar 0.2 MPH N

The bottom of the page shows "Map data ©2016 Google", a scale bar for 2 km, and links for "Terms of Use" and "Report a map error".

Data graph on aprs.fi

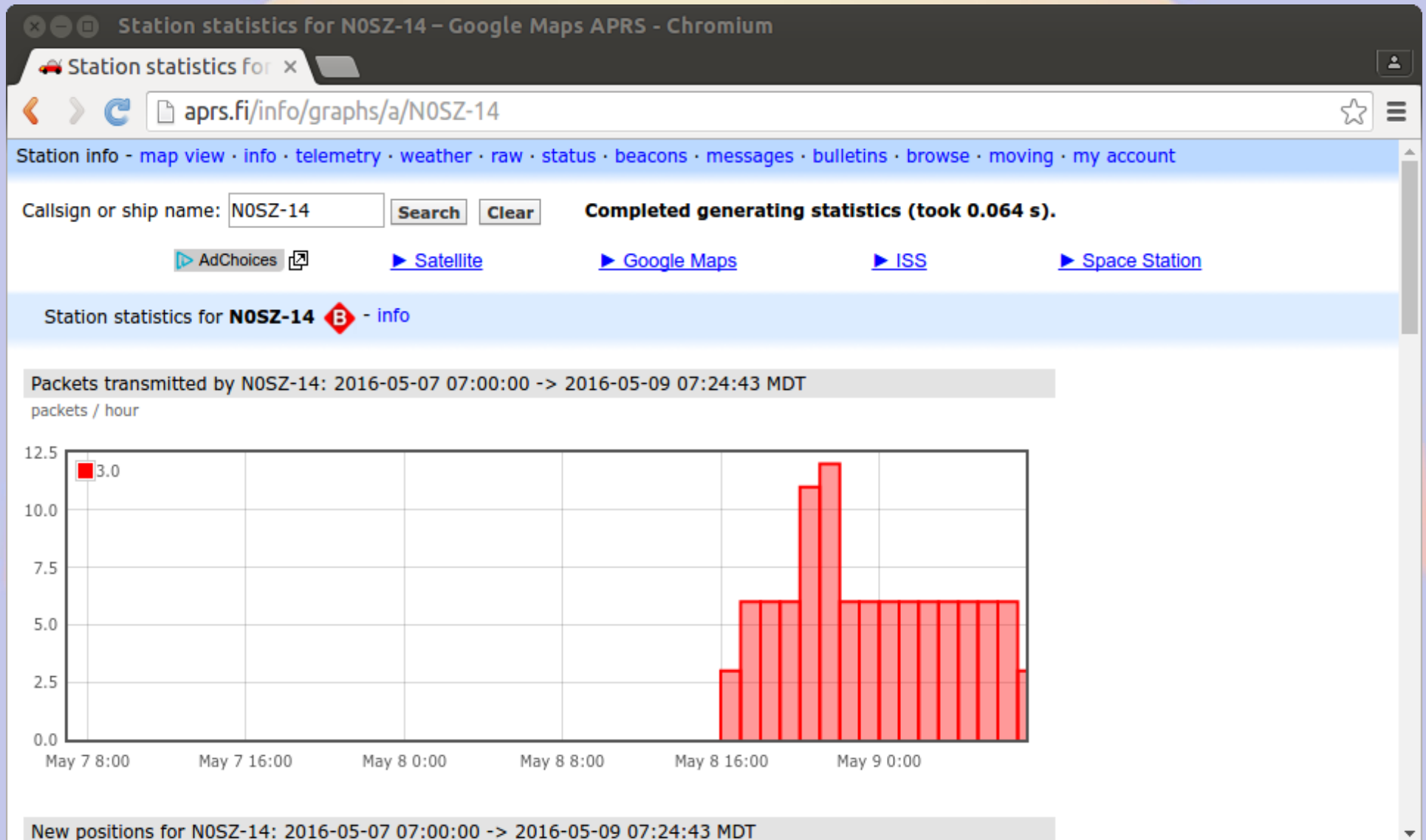

Adding device ports

- **Beaglebone has 5 serial ports**
 - **Stack 4 TNC-Blacks**
 - **Attach external devices via headers**
- **Raspberry Pi has 1 serial port**
 - **Access TNC-Pi via I2C bus**
 - **Requires reprogramming of TNC-Pi**

Reprogramming TNC

- **Disable BPQ to have exclusive access to the TNC device**
 - `systemctl disable bpq.service`
 - `systemctl stop bpq.service`
- **Turn off power between steps**
- **Enable BPQ when done**
 - `systemctl enable bpq.service`
 - `systemctl start bpq.service`

Enable I2C kernel modules

```
willem@aid2: ~  
File Edit View Search Terminal Help  
Raspberry Pi Software Configuration Tool (raspi-config)  
A1 Overscan You may need to configure oversca ↑  
A2 Hostname Set the visible name for this Pi  
A3 Memory Split Change the amount of memory made  
A4 SSH Enable/Disable remote command lin  
A5 Device Tree Enable/Disable the use of Device  
A6 SPI Enable/Disable automatic loading  
A7 I2C Enable/Disable automatic loading  
A8 Serial Enable/Disable shell and kernel m  
A9 Audio Force audio out through HDMI or 3  
AA GL Driver Enable/Disable experimental desk ↓  
  
<Select> <Back>
```

Check current parameters

```
willem@aid2: ~/BPQ
File Edit View Search Terminal Help
willem@aid2:~/BPQ < sudo ./pitnc_getparams 0 0
Using Serial port /dev/ttyAMA0
    PIC Software Version          1
01 TXDelay - Zero means use ADC  40
02 Persistence                    64
03 Slottime (in 10 mS)           10
04 TXTail                         0
05 Full Duplex - Not used        0
06 Our Channel (Hex)             00
07 I2C Address (0 = async) Hex   00
    ADC Value                     69
8 1 28 40 a 0 0 0 0 45 2e c0 sum 0
willem@aid2:~/BPQ $
```

Set I2C address to 16 (0x10)

```
willem@aid2: ~/BPQ
File Edit View Search Terminal Help
willem@aid2:~/BPQ $ sudo ./pitnc_setparams 0 0 7 16

PIC Software Version          1
01 TXDelay - Zero means use ADC 40
02 Persistence                 64
03 Slottime (in 10 mS)        10
04 TXTail                      0
05 Full Duplex - Not used      0
06 Our Channel (Hex)          00
07 I2C Address (0 = async) Hex 10
   ADC Value                   69
8 1 28 40 a 0 0 0 10 45 3e c0 sum 0
willem@aid2:~/BPQ $
```

Check parameters

```
willem@aid2: ~  
File Edit View Search Terminal Help  
willem@aid2:~ $ sudo ./pitnc_getparams 1 16  
  
    PIC Software Version          1  
01 TXDelay - Zero means use ADC 40  
02 Persistence                    64  
03 Slottime (in 10 mS)           10  
04 TXTail                         0  
05 Full Duplex - Not used        0  
06 Our Channel (Hex)             00  
07 I2C Address (0 = async) Hex   10  
    ADC Value                     69  
8 1 28 40 a 0 0 0 10 45 3e c0 sum 0  
willem@aid2:~ $
```

Adding a Second RF Port

- **Must use I2C since rPi has only one serial port**
- **Convert first TNC to I2C before mounting second TNC**
- **Test it to make sure it works**
- **Add second TNC**
- ***Power down between steps***

Set I2C address for 2nd TNC

```
willem@aid2: ~  
File Edit View Search Terminal Help  
willem@aid2: $ sudo ./pitnc_setparams 0 0 7 17  
  
PIC Software Version          1  
01 TXDelay - Zero means use ADC 40  
02 Persistence                 64  
03 Slottime (in 10 mS)        10  
04 TXTail                      0  
05 Full Duplex - Not used     0  
06 Our Channel (Hex)          00  
07 I2C Address (0 = async) Hex 11  
ADC Value                      62  
8 1 28 40 a 0 0 0 11 3e 44 c0 sum 0  
willem@aid2:~ $
```

BPQ Port 1

File Edit View Search Terminal Help

AC0KQ bpq-config version 1.0

Port Configuration
Select port to

- 1 Add port
- 2 Delete port
- 3 Port 1**
- 4 Port 2

<Select> <Finish>

Port 1 is for BBS/RMS

File Edit View Search Terminal Help

AC0KQ bpq-config version 1.0

Configure port

Set Parameter

Type	Packet
Device Type	Serial
Device Number	1
Frequency	145050
Digipeat	Yes
Power	40
Height	50
Gain	6

<Set> <Finish>

BPQ Port 2

File Edit View Search Terminal Help

AC0KQ bpq-config version 1.0

Port Configuration

Select port to

- 1 Add port
- 2 Delete port
- 3 Port 1
- 4 Port 2

<Select> <Finish>

Port 2 is for APRS

File Edit View Search Terminal Help

AC0KQ bpq-config version 1.0

Configure port

Set Parameter

Type	APRS
Device Type	Serial
Device Number	2
Frequency	144390
Digipeat	Yes
Power	50
Height	50
Gain	6

<Set> <Finish>

BPQ Ports Page

N0SZ-7's BPQ32 We x

192.168.11.88:8008/Node/Ports.html

BPQ32 Node N0SZ-7

[Routes](#) [Nodes](#) [Ports](#) [Links](#) [Users](#) [Stats](#) [Terminal](#) [Driver Windows](#) [Stream Status](#) [APRS Pages](#) [Mail Server Pages](#) [SYSOP Signin](#) [Edit Config](#)

Ports

Port	Driver	ID	Beacons
1	ASYNC	145.050 MHz 1200 bps	Beacons
2	ASYNC	144.390 MHz 1200 bps	Beacons
3	TELNET	Telnet Server	
4	BPQAXIP	AX/IP/UDP	Beacons

Advanced Configuration

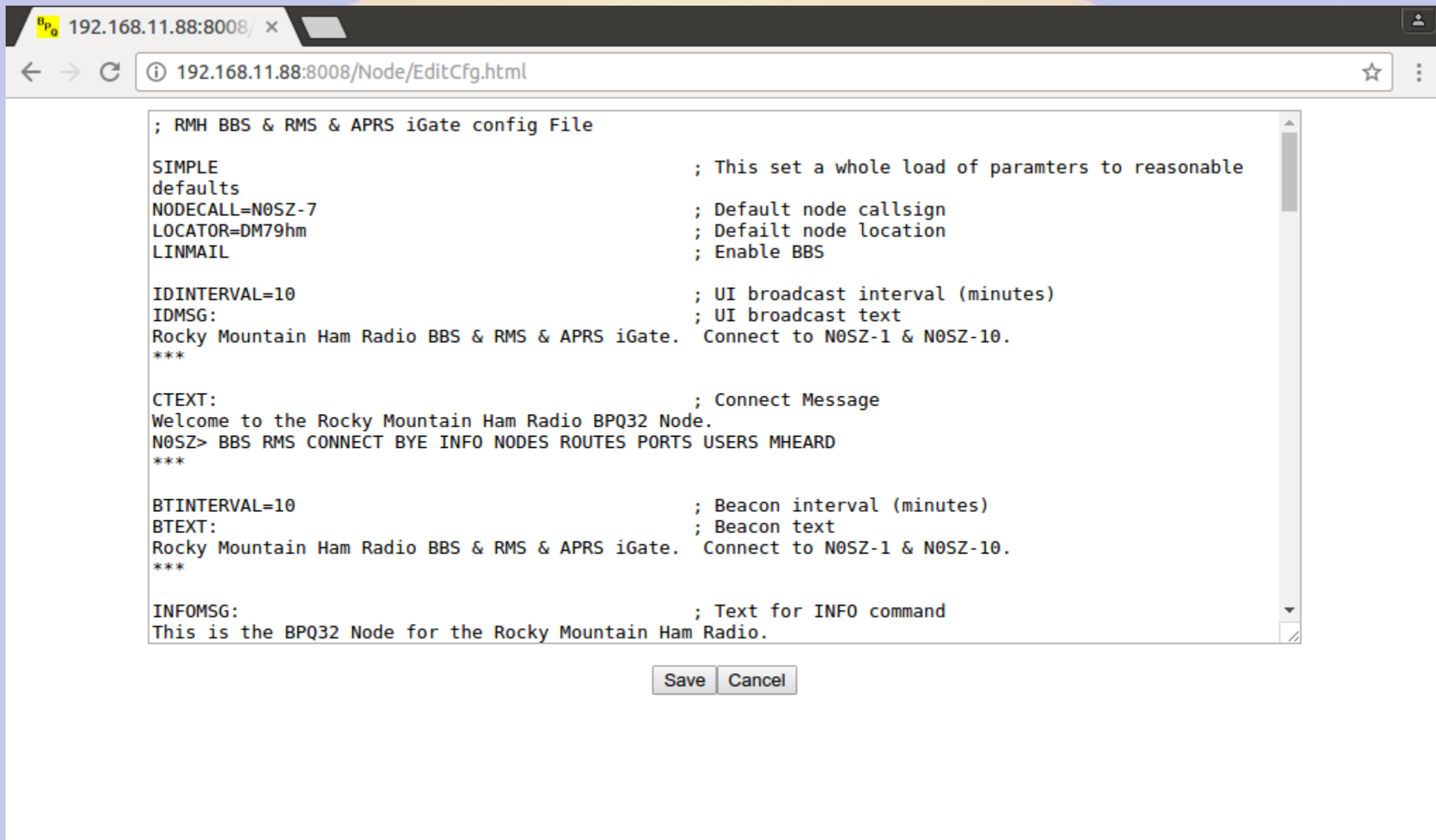

BPQ 192.168.11.88:8008/ x

← → ↻ ⓘ 192.168.11.88:8008/Node/EditCfg.html ☆ ⋮

```
; RMH BBS & RMS & APRS iGate config File

SIMPLE                ; This set a whole load of paramters to reasonable
defaults
NODECALL=N0SZ-7      ; Default node callsign
LOCATOR=DM79hm       ; Default node location
LINMAIL              ; Enable BBS

IDINTERVAL=10        ; UI broadcast interval (minutes)
IDMSG:                ; UI broadcast text
Rocky Mountain Ham Radio BBS & RMS & APRS iGate.  Connect to N0SZ-1 & N0SZ-10.
***

CTEXT:                ; Connect Message
Welcome to the Rocky Mountain Ham Radio BPQ32 Node.
N0SZ> BBS RMS CONNECT BYE INFO NODES ROUTES PORTS USERS MHEARD
***

BTINTERVAL=10        ; Beacon interval (minutes)
BTEXT:                ; Beacon text
Rocky Mountain Ham Radio BBS & RMS & APRS iGate.  Connect to N0SZ-1 & N0SZ-10.
***

INFOMSG:              ; Text for INFO command
This is the BPQ32 Node for the Rocky Mountain Ham Radio.
```

Save Cancel

Adding a new service

- BPQ adds new services via TCP/IP
- BPQ connects to local port
- Received stream piped to *stdin*
- Transmits output from *stdout*
- First line is connected station call

Monitor service

- **Written in Perl**
- **Interprets commands**
- **Used to get system time and disk**
- **Bye to exit**
- **Mapped to N0SZ-2 and port 8004**

Command Port

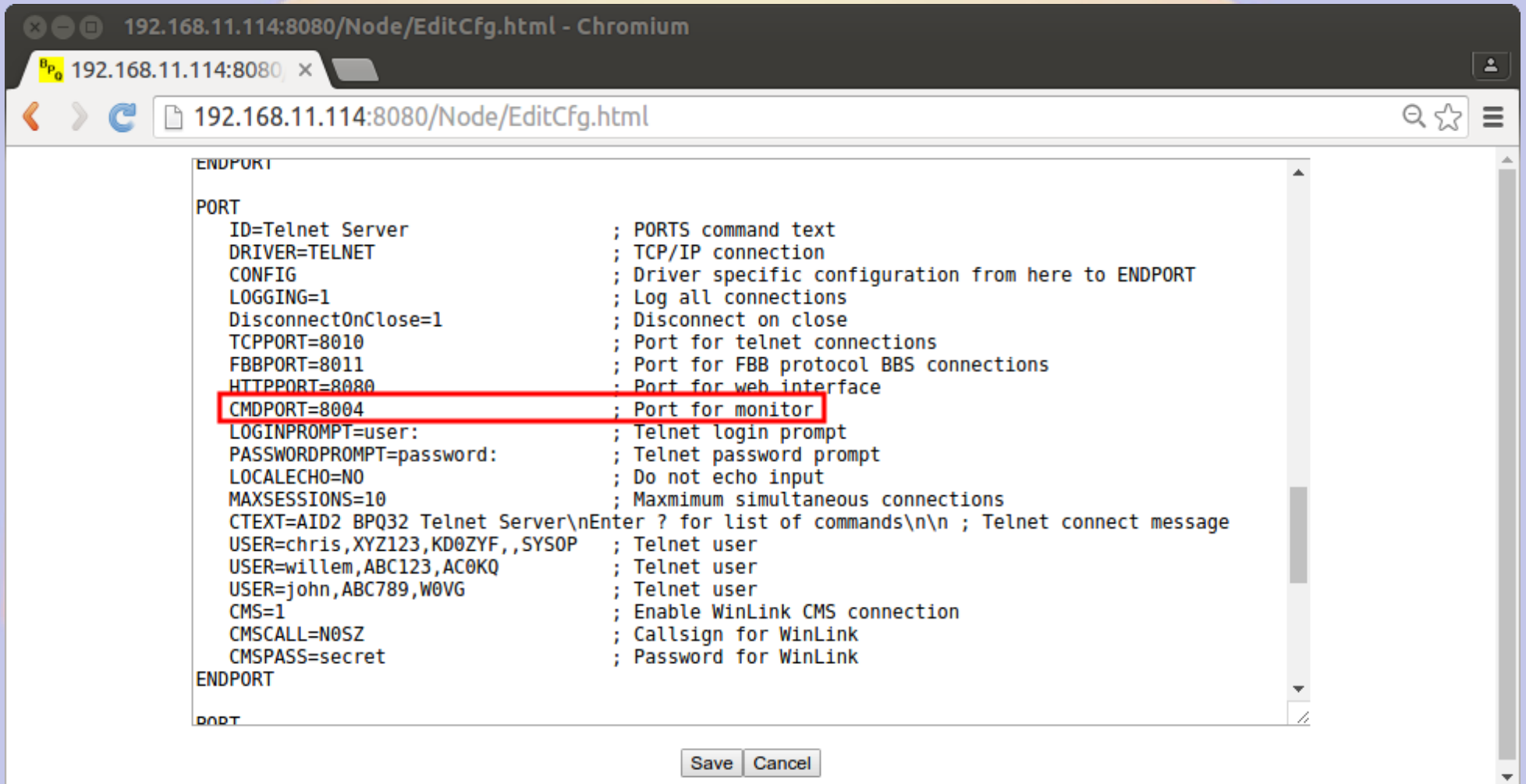

192.168.11.114:8080/Node/EditCfg.html - Chromium

192.168.11.114:8080

192.168.11.114:8080/Node/EditCfg.html

```
ENDPORT
PORT
  ID=Telnet Server           ; PORTS command text
  DRIVER=TELNET             ; TCP/IP connection
  CONFIG                    ; Driver specific configuration from here to ENDPORT
  LOGGING=1                 ; Log all connections
  DisconnectOnClose=1      ; Disconnect on close
  TCPPORT=8010              ; Port for telnet connections
  FBBPORT=8011              ; Port for FBB protocol BBS connections
  HTTPPORT=8080             ; Port for web interface
  CMDPORT=8004              ; Port for monitor
  LOGINPROMPT=user:         ; Telnet login prompt
  PASSWORDPROMPT=password:  ; Telnet password prompt
  LOCALECHO=NO              ; Do not echo input
  MAXSESSIONS=10           ; Maximum simultaneous connections
  CTEXT=AID2 BPQ32 Telnet Server\nEnter ? for list of commands\n\n ; Telnet connect message
  USER=chris,XYZ123,KD0ZYF,,SYSOP ; Telnet user
  USER=willem,ABC123,AC0KQ  ; Telnet user
  USER=john,ABC789,W0VG     ; Telnet user
  CMS=1                     ; Enable WinLink CMS connection
  CMSCALL=N0SZ              ; Callsign for WinLink
  CMSPASS=secret            ; Password for WinLink
ENDPORT
PORT
```

Save Cancel

Application

```
PORT
ID=AX/IP/UDP           ; Displayed by PORTS command
DRIVER=BPQAXIP         ; Uses BPQAXIP
QUALITY=220            ; Quality factor applied to node broadcasts heard on
MINQUAL=165           ; Entries in the nodes table with qualities greater or
MAXFRAME=5             ; Max outstanding frames (1 thru 7)
FRACK=3000             ; Level 2 timeout in milliseconds
RESPTIME=1000         ; Level 2 delayed ack timer in milliseconds
RETRIES=5              ; Level 2 maximum retry value
PACLEN=236            ; Maximum packet length
CONFIG                 ; Driver specific configuration from here to ENDPOINT
MHEARD                ; Keep heard stats
UDP 10093              ; UDP port
AUTOADDMAP            ; Automatically add new connections
BROADCAST NODES      ; Broadcast
MAP K0NTS argon.schreuder.us UDP 10093 B ; AXIP to K0NTS
MAP N4ATA n4ata.dyndns.org  UDP 10093 B ; AXIP to N4ATA
MAP KD0DPX 192.168.11.88   UDP 10093 B ; AXIP to KD0DPX
ENDPOINT

APPLICATION 1,BBS,,N0SZ-1,AID2BBS,255 ; BBS Application
APPLICATION 2,RMS,C 3 CMS,N0SZ-10,AID2RMS,255 ; CMS Application
APPLICATION 3,MON,C 3 HOST 0,N0SZ-2,AID2XX,255 ; MON Application
APPLICATION 32,TALK,,N0SZ ; INC Application
```

Save Cancel

systemd Socket Service

`/lib/systemd/systemd/mon.socket` `/lib/systemd/systemd/mon@.service`

[Unit]

Description=MON
socket

[Socket]

ListenStream=8004
Accept=yes

[Install]

WantedBy=sockets.target

[Unit]

Description=MON server

[Service]

ExecStart=/home/willem/BPQ/mon.
pl
StandardInput=socket

mon.pl

```
#!/usr/bin/perl -w -T

# Monitor server
# Willem AC0KQ

use strict;
$ENV{PATH} = '/bin';

# Set autoflush
my $old_fh = select(STDOUT);
$| = 1;
select($old_fh);

# Read callsign of connecting station
my $call = <STDIN>;
$call =~ s/^\s*//;
$call =~ s/\s*$//;

#
# Match command
#
sub match
{
    my ($cmd,$pat) = @_;
    $pat = substr($pat,0,length($cmd));
    return ($pat eq $cmd);
}

# Welcome message
print "N0SZ Monitor\nConnect from '$call'\n> ";
```

```
# Read lines
while(my $line = <STDIN>)
{
    # Split on whitespace
    my ($cmd,@line) = split(' ', $line);
    $cmd = defined($cmd) ? lc $cmd : '';

    # Do nothing
    if ($cmd eq '')
    {
    }
    # Help
    elsif($cmd eq '?')
    {
        print "Commands: time disk bye\n";
    }
    # Bye
    elsif (match($cmd,'bye'))
    {
        die "73 $call\n";
    }
    # Print time
    elsif (match($cmd,'time'))
    {
        print "Time ".localtime(),"\n";
    }
    # Print disk usage
    elsif (match($cmd,'disk'))
    {
        my @disk = `df -kh /`;
        my (undef,$size,$used,$avail,$pct) = split(' ', $disk[1]);
        print "Disk size=$size used=$used ($pct) available=$avail\n";
    }
    else
    # Unknown command
    {
        print "Unknown command $cmd args @line\n";
    }
    # Print command prompt
    print "N0SZ> ";
}
}
```

Enable the service

- Enable and start the service
 - sudo systemctl enable mon.socket
 - sudo systemctl start mon.socket

```
willem@bashful: ~  
File Edit View Search Terminal Help  
cmd c N0SZ-2  
cmd:*** CONNECTED to N0SZ-2  
Connected to  
N0SZ Monitor  
Connect from 'AC0KQ'  
> ?  
Commands: time disk bye  
N0SZ> t  
Time Sun May 8 17:48:49 2016  
N0SZ> d  
Disk size=15G used=3.5G (26%) available=11G  
N0SZ> b  
73 AC0KQ  
*** DISCONNECTED  
cmd: 
```

Time

- rPi and BBB does not have a real time clock, sets time using NTP
- If network does not recover after power failure, messages may be purged
- Add DS1307 RTC from Adafruit or similar device

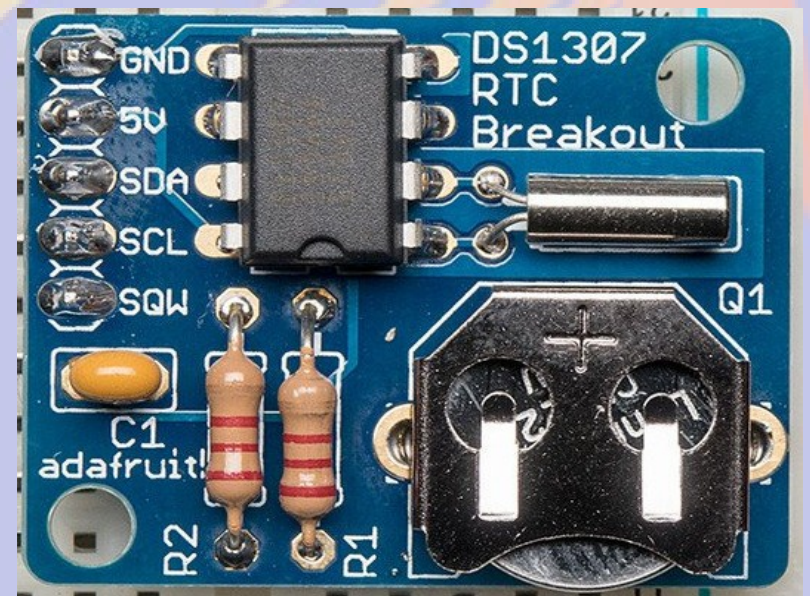

Power Backup

- With a 6600 mAh LiPo battery the *PowerCape* will run a BB and TNC for more than a day
- Controlled shutdown on low battery

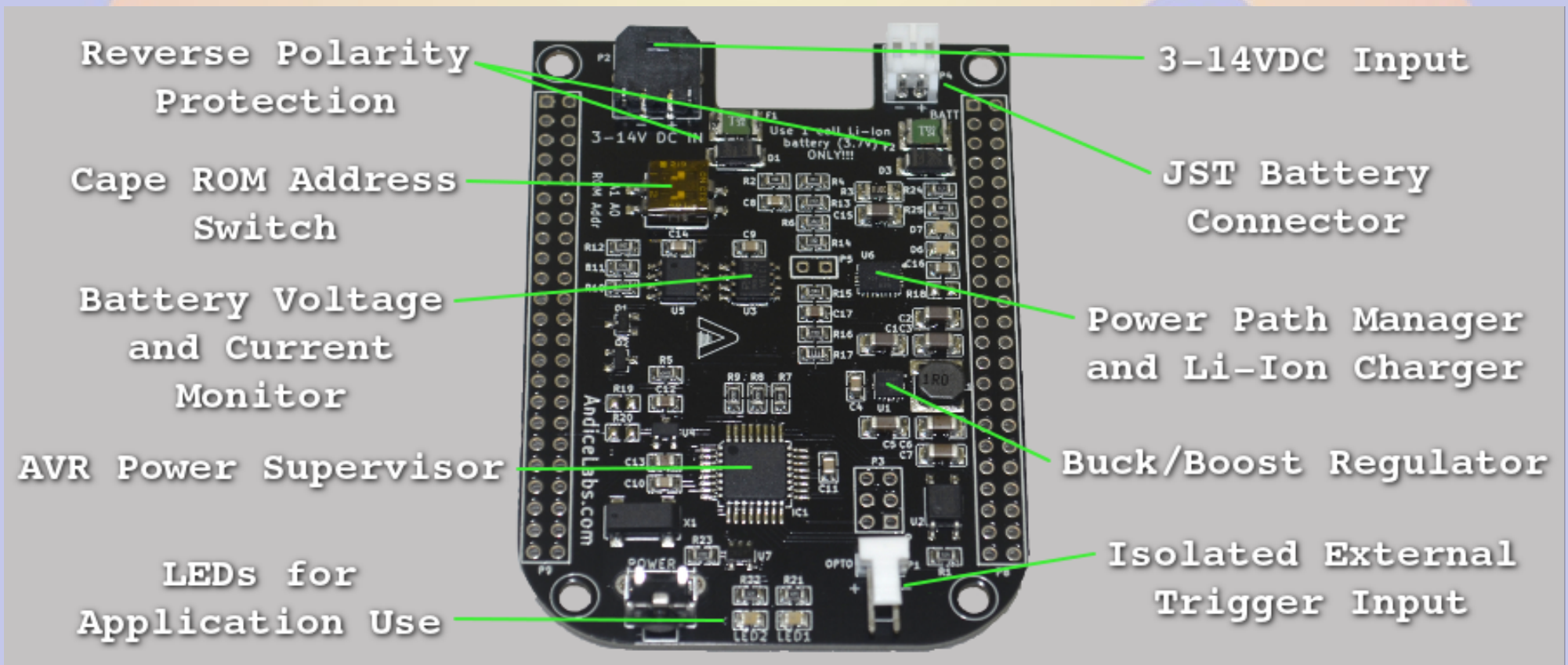

Beaglebone Notes

- The BB configuration is similar except that up to 4 TNC can be run as */dev/ttyO1* - */dev/ttyO5*
- *mkbpq* puts web configuration on port 8008 since 8080 is used

What breaks BPQ

- Things that mess with serial and I2C
 - Raspberry Pi 3 (bluetooth, CPU freq)
 - getty on rPi
 - Debian 8 on Beaglebone
- Use *lsof* and *i2c-tools* to debug
 - If BPQ receives (stations in *mh*) but no transmit, a device clash is likely
- Run *sudo ./pilinbpq* from command line

Updating BPQ

- BPQ is updated regularly
- *bpq-config* Download will download the latest version of executables and the matching HTML pages
- After downloading restart BPQ

BPQ with external TNC

- **BPQ supports Pactor modems including channel steering**
- **Attach via serial port**
- **Configure in BPQ**
 - **DRIVER=SCSpactor**
 - **RIGCONTROL to steer**

About bpq-config

- ***bpq-config*** is designed to get you started
 - It covers most installations, but not all
- It keeps its on configuration file **`.bpqconfig`**
 - Easier to parse
 - Hand edits are lost when using bpq-config
 - Version 1.1 *may* parse `bpq32.cfg` instead
- This is new software
 - Bug reports and improvements are welcome
 - Patches are even more welcome



Part 3

AllStarLink Repeater

What is AllStarLink?

- Asterisk VOIP software for radio
- Interfaces with radio via URiX
 - CM119 USB audio chip
 - DB25 connector
- Can roll your own with equivalent fob



Installing AllStarLink

- **Download from www.hamviop.com**
 - Burn image to SD card
- **Program your radio/repeater**
 - Set radio to encode/decode CTCSS
 - On Motorola set accessories to output COS & PL on pin 8
- **Tune a receiver to to the radio frequency**
- **Power up rPi**
 - Allison will announce the IP address

Initial Login (password is root)

```
willem@bashful: ~  
File Edit View Search Terminal Help  
willem@bashful:~$ ssh -p 222 root@192.168.100.237  
root@192.168.100.237's password:  
RPi2-3 Version 1.02beta Allstar - March 26, 2016 - WA3DSP, KB4FXC, W0AMN  
  
It appears that this is the first time this system  
has been booted. It would be prudent to change a few  
key settings now for the sake of security and convenience.  
Once this information is entered, the system will reboot  
and the next time the system boots, this message will not  
re-appear.  
  
Would you like to run first setup now ([y],n) ?   
*****  
Initial setup information  
  
Enter new UNIX password:   
Retype new UNIX password:   
passwd: password updated successfully  
Enter Node Number: 40552
```

Set Time Zone 1

```
willem@bashful: ~  
File Edit View Search Terminal Help  
*****  
Time Zone Configuration  
  
By default, the time zone is set to:  
  
    Time zone: American/Eastern  
  
A correct time zone entry will allow the system clock to report the  
correct time.  
  
Do you want to change the default time zone (American/Eastern) ([y],n) ? 
```

CW or Voice ID

```
willem@bashful: ~  
File Edit View Search Terminal Help  
-----  
Asterisk can use either voice or CW id for FCC identification.  If you  
select voice id a simple gsm voice ID audio file will be generated.  
This file is located at "/etc/asterisk/local/" and is called  
"node_id.gsm".  
  
If you select "y" to voice id, then a voice id will be created.  If you  
select "n", then the default CW id will be used.  
-----  
Do you want to use voice id ([n],y): ? 
```

Network Port

```
willem@bashful: ~  
File Edit View Search Terminal Help  
-----  
Port 4569 is the default iax protocol port. If you are using just  
one server on your public IP address, then you can skip this step  
by hitting return to select the default value.  
-----  
Enter Bind Port [4569]: 
```

Duplex

```
willem@bashful: ~  
File Edit View Search Terminal Help  
-----  
Duplex setting  
  
This setting setups up the different duplex modes for your allstar node.  
Here are the values and their meaning:  
  
0 = half duplex (telemetry and courtesy tones do not transmit)  
1 = semi-half duplex (telemetry and courtesy tones transmit, but not  
  repeated audio (Default)  
2 = normal full-duplex mode)  
3 = full-duplex mode, without repeated audio from main input source  
4 - Normal except no main repeat audio during autopatch only  
  
Normally for a simplex node, you would choose "1". For a repeater, you  
would choose "2".  
  
If you want a "silent" simplex node (no courtesy tones or telemetry),  
you would choose "0".  
  
-----  
Enter the desired duplex mode [1]: 
```

Node Password

```
willem@bashful: ~  
File Edit View Search Terminal Help  
-----  
The node password is the password that is assigned with your node  
number. If you don't have this handy it can be retrieved by logging  
into your account at allstarlink.org and checking node 40552  
password. The password is a 6 digit number.  
-----  
Enter Node password for node 40552 []: [REDACTED]
```

IAX Password

```
willem@bashful: ~  
File Edit View Search Terminal Help  
-----  
Asterisk Allstar has the capability to receive connections from a  
Windows computer using a program called iaxRpt. In order to do this you  
need to specify a password which will be used to confirm connections  
from that program. You would then use this same password to configure  
a iaxRpt account on a Windows computer. Information on how to  
configure iaxRpt can be found at the hamvoip.org website.  
-----  
Do you want to configure the password for an iaxrpt connection ([y],n): ? n
```

Simple USB Configuration 1

```
willem@bashful: ~  
File Edit View Search Terminal Help  
-----  
You now will need to review and configure simpleusb.conf. In particular  
the 'carrier from' needs to be set to match your radios COS polarity.  
See the configuration howto on the hamvoip.org web page for more info  
on configuring simpleusb and setting audio levels.  
-----  
Do you want to configure Simple USB settings now: ([n],y): ? y
```

Simple USB Configuration 2

```
willem@bashful: ~
File Edit View Search Terminal Help
-----
[Introduction of script]
This script will create the configuration file for the simple usb device.

During each setting, you will see the currently defined setting followed
by a description of the values. You will be prompted with a simple yes or
no question.

NOTE, you can run this script as many times as required. It will remember
the last setting used. If it's run for the first time, you will be prompted
for a radio selection which will load its default settings. Please review
these settings when you are prompted and change if necessary.

-----
Do you wish to continue: ([n],y): ? y
```

Select Radio

```
willem@bashful: ~  
File Edit View Search Terminal Help  
-----  
0 - GM300_cos_invert  
1 - GM300_cos_noninvert  
2 - Dorji_Transceiver_Module  
3 - Alinco_DRx35  
4 - Baofeng_ba-666  
5 - default  
If radio type is not shown above, select 'default'  
-----  
Enter number from above to select radio type: 5
```

EEPROM on URI

```
willem@bashful: ~
File Edit View Search Terminal Help
-----
eeprom Setting
  eeprom=0
                ; 1 = Indicates that an EEPROM internal to the radio
                ;      adapter and cable is expected.
                ; 0 = no warning message if no EEPROM found.

Normally, you will select "n" unless you are using an internal eeprom.
-----
Are you using an eeprom in your URI/radio ([n],y): ? 
```

URI Type

```
willem@bashful: ~
File Edit View Search Terminal Help
-----
Hardware Type setting
  hdwtype=0
                                ; USB Sound Adapter Hardware Type
                                ; Set to 0 for DMK Eng. URI, or USB sound adapaters
                                ;   modified using the instructions from usbfov.pdf.
                                ; Set to 1 for DingTel/W9SH modified usb adapters.

(To be removed, use default hdwtype=0, only option for bbb is hdwtype=0)

Answer "n" to this question, if using a URI or modified FOB.
-----
Are you using a Dingotel/Shp interface ([n],y): ? 
```

Audio Boost

```
willem@bashful: ~  
File Edit View Search Terminal Help  
-----  
Receiver Audio Boost  
rxboost=1  
  
; Rx Audio Boost  
; 0 = 20db attenuator inserted,  
; 1= 20db attenuator removed  
; Set to 1 for additional gain if using a low-level  
; receiver output.  
  
Answer "y" if you are using a low-level receiver output.  
-----  
Should the receive audio be boosted (attenuator removed) ([y],n): ? 
```

Carrier Detect (COR or COS)

```
willem@bashful: ~  
File Edit View Search Terminal Help  
-----  
Carrier Detection  
  carrierfrom=usbinvert  
  
          ; Options - no,usb,usbinvert  
          ; no - no carrier detection at all  
          ; usb - via USB radio adapter COR connection  
          ; usbinvert - same as above but inverted polarity.  
  
Normally, you will be using this option. This is the COS (carrier detection)  
which indicates that a carrier is present. This signal comes for the radio to  
the modified FOB or URI. This supports the option to invert the detected signal  
which depends on the radio.  
-----  
Do you want to use carrier detection ([y],n): ?  
  
  Does the COR line need to be inverted ([y],n): ? 
```

CTCSS Decode

```
willem@bashful: ~
File Edit View Search Terminal Help
-----
CTCSS Decoding
  ctcssfrom=no

          ; CTCSS Decoder Source
          ; Options = no,usb,dsp
          ; no - CTCSS decoding, system will be carrier squelch
          ; usb - CTCSS decoding using input from USB adapter
          ; usbinvert - same as above but inverted polarity.

Some radios use the CTCSS signal to indicate that a CTCSS signal is preset,
like COS, it provides a method of signal detection and indicates that a
carrier is present. This signal comes for the radio to the modified FOB or
URI. This supports the option to invert the detected signal which depends
on the radio.
-----
Do you want to use CTCSS decoding ([n],y): ? 
```

Transmit Left Channel

```
willem@bashful: ~
File Edit View Search Terminal Help
-----
TX Mixer A
  txmixa=voice

; Tx Mix Output Channel A (Left) Output Type
; Options = no,voice,tone,composite,auxvoice
; no - Do not output anything
; voice - output voice only
; tone - CTCSS tone only
; composite - voice and tone
; auxvoice - voice output for monitoring

; Left channel output: no,voice,tone,composite,auxvoice
; no - Do not output anything
; voice - output voice only

The current value for this parameter is: voice. Nomally, this is set for
"composite".
-----
Do you want to change the TX Mix A setting ([n],y): ? 
```

Transmit Right Channel

```
willem@bashful: ~  
File Edit View Search Terminal Help  
-----  
Transmit Mixer B  
  txmixb=no  
  
          ; Tx Mix Output Channel B (Left) Output Type  
          ; Options = no,voice,tone,composite,auxvoice  
          ; no - Do not output anything  
          ; voice - output voice only  
          ; tone - CTCSS tone only  
          ; composite - voice and tone  
          ; auxvoice - voice output for monitoring  
  
The current value for this parameter is: no. Nomally, this is set for  
"no".  
-----  
Do you want to change the TX Mix B setting ([n],y): ? 
```

PTT

```
willem@bashful: ~  
File Edit View Search Terminal Help  
-----  
PTT Setting  
invertptt=0  
  
; Invert PTT 0 = ground to transmit, 1 = open to transmit  
; This is the collector lead of the 2n4401 on the modified  
; usb sound fob.  
  
Please refer to the howto for the procedure to do this.  
-----  
Should the PTT be grounded to transmit ([y],n): ? 
```

Filter CTCSS

```
willem@bashful: ~  
File Edit View Search Terminal Help  
-----  
PL Filter Setting  
  plfilter=yes  
                                ; enable PL filter  
                                ; yes, enabled  
                                ; no, disabled  
  
**Only use if necessary for your installation**  
Some radios require additional filtering the the PL tones, this will help  
attenuate this signal from the receiver.  
-----  
Should the plfilter be enabled ([y],n): ? 
```

Flat or Speaker Audio

```
willem@bashful: ~  
File Edit View Search Terminal Help  
-----  
De-emphasis Filter  
  deemphasis=no  
                ; enable de-emphasis (input from discriminator)  
                ; yes, enabled  
                ; no, disabled  
  
**Only use if necessary for your installation**  
-----  
Should the deemphasis be enabled ([n],y): ? 
```

Flat or Mic Audio

```
willem@bashful: ~  
File Edit View Search Terminal Help  
-----  
Pre-emphasis Filter  
preemphasis=no  
                ; enable pre-emphasis (output to Tx)  
                ; yes, enabled  
                ; no, disabled  
  
**Only use if necessary for your installation**  
-----  
Should the preemphasis be enabled ([n],y): ? 
```

Audio Delay

```
willem@bashful: ~  
File Edit View Search Terminal Help  
-----  
rxaudiodelay parameter  
  rxaudiodelay=0  
      ; default value is 0  
      ; Squelch tail delay in 20ms frames. Values are 0  
      ; (no delay) to 24 (480ms delay)  
      ; Typical values would range from 3-12 (60-240ms)  
  
Please refer to the documentation prior to changing from the default  
value.  
-----  
Enter the value of rxaudiodelay [0] : 
```

Set Audio Levels

```
willem@bashful: ~  
File Edit View Search Terminal Help  
-----  
Audio Levels  
  
If you know the audio values for your node setup, you can modify them  
now. If not, please run "simpleusb-tune-menu" program at the Linux  
prompt to properly set your sound levels.  
  
-----  
Do you want to set your audio levels for your node now ([n],y): ? y
```

Receive Audio Levels

```
willem@bashful: ~  
File Edit View Search Terminal Help  
-----  
RX Mixer Value  
  rxmixerset=500  
  
This value sets the Receiver Audio Levels or incoming audio levels "from"  
the node radio.  
-----  
  
Enter the new value for the RX Mixer Level [500]: 
```

Transmit Left Audio Levels

```
willem@bashful: ~  
File Edit View Search Terminal Help  
-----  
TX Mixer A Value  
  txmixaset=500  
  
This value sets the Transmit Audio Levels or outgoing audio on the  
A output side "to" the node radio.  
-----  
  
Enter the new value for the TX Mixer A Level [500]: 
```

Transmit Right Audio Levels

```
willem@bashful: ~  
File Edit View Search Terminal Help  
-----  
TX Mixer B Value  
  txmixbset=500  
  
This value sets the Transmit Audio Levels or outgoing audio on the  
B output side "to" the node radio.  
-----  
  
Enter the new value for the TX Mixer B Level [500]: █
```

Done

```
root@pi40552:~  
File Edit View Search Terminal Help  
-----  
(final info)  
  
After any simpleusb.conf changes you should do an Asterisk restart. This  
will restart and reload the Asterisk modules. These simpleusb changes will  
not take effect until Asterisk is restarted.  
  
If needed, please run "simpleusb-tune-menu" program at the Linux prompt to set  
your sound levels.  
-----  
Do you want to restart Asterisk to enable selections: ([y],n): ?  
Restarting Asterisk..  
Restarting Asterisk...  
[root@pi40552 ~]#
```

Make it Transmit

```
root@pi40552:~  
File Edit View Search Terminal Help  
[root@pi40552 ~]# asterisk -r  
Asterisk , Copyright (C) 1999 - 2008 Digium, Inc. and others.  
Created by Mark Spencer <markster@digium.com>  
Asterisk comes with ABSOLUTELY NO WARRANTY; type 'core show warranty' for detail  
s.  
This is free software, with components licensed under the GNU General Public  
License version 2 and other licenses; you are welcome to redistribute it under  
certain conditions. Type 'core show license' for details.  
=====  
Connected to Asterisk  currently running on pi40552 (pid = 252)  
Verbosity is at least 3  
pi40552*CLI> rpt fun 40552 *81  
  -- <DAHDI/pseudo-917589702> Playing 'rpt/goodafternoon' (language 'en')  
  -- <DAHDI/pseudo-917589702> Playing 'rpt/thetimeis' (language 'en')  
  -- <DAHDI/pseudo-917589702> Playing 'digits/2' (language 'en')  
  -- <DAHDI/pseudo-917589702> Playing 'digits/20' (language 'en')  
  -- <DAHDI/pseudo-917589702> Playing 'digits/p-m' (language 'en')  
  -- Hungup 'DAHDI/pseudo-917589702'  
pi40552*CLI> 
```

Set Levels

```
root@pi40552:/etc/asterisk
File Edit View Search Terminal Help
[root@pi40552 asterisk]# simpleusb-tune-menu

active (command) USB Radio device is [usb]
1) Select USB device
2) Set Rx Voice Level (using display)
3) Set Transmit A Level
4) Set Transmit B Level
E) Toggle Echo Mode (currently Disabled)
F) Flash (Toggle PTT and Tone output several times)
P) Print Current Parameter Values
S) Swap Current USB device with another USB device
T) Toggle Transmit Test Tone/Keying (currently Disabled)
W) Write (Save) Current Parameter Values
0) Exit Menu

Please enter your selection now: 
```

/etc/asterisk/simpleusb.conf

- Configuration for Motorola SM50

```
[usb]
eeprom=0
hdwtype=0
rxboost=1
carrierfrom=usb
ctcssfrom=usb
txmixa=voice
txmixb=no
invertptt=0
duplex=0
plfilter=yes
deemphasis=no
preemphasis=yes
rxaudiodelay=0
```

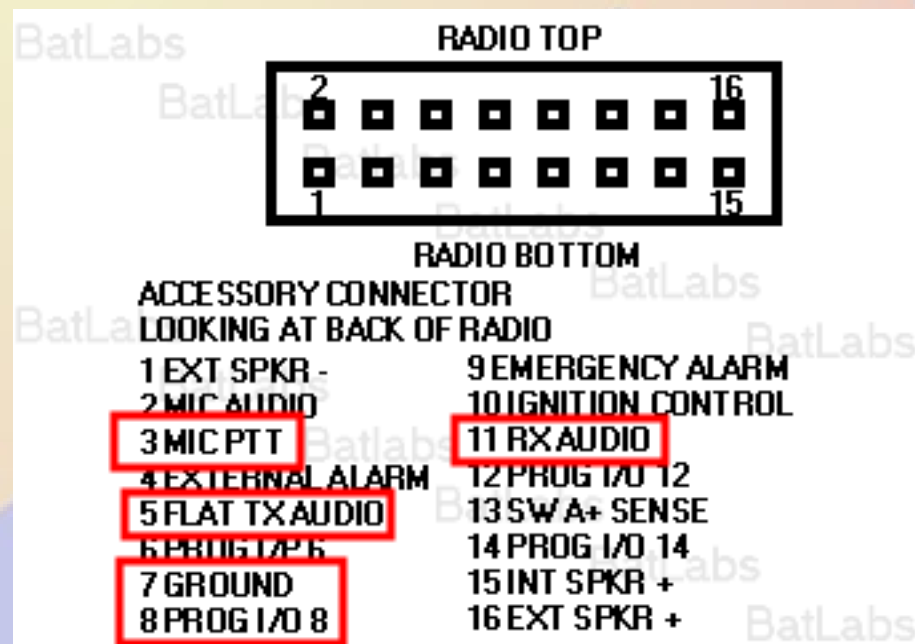

Update /srv/httpd/index.html

```
<html>
<head>
<title>40552</title>
</head>
<body>
<b>Node 40552</b>
<br><a href=allmon2/link.php?nodes=40552>AllMon</a>
<br><a href=cgi-bin/ltnodes_web?node=40552>ltnodes</a>
</body>
</html>
```

Edit AllMon Files

- **Edit /srv/httpd/allmon2/allmon.ini.php**
 - Change XXXXX to node number
 - Change passwd
- **Edit /etc/asterisk/manager.conf**
 - Add the same password to secret =
- **Restart allstar**
 - astres.sh

AllMon2

The screenshot shows a Chromium browser window with the title "PI40552 | Allmon | 40552 - Chromium". The address bar contains the URL "pi40552/allmon2/link.php?nodes=40552". The page header features the text "Allstar Monitor II" and "Monitoring the World One Node at a Time" on a green background, along with the "AllStar Link" logo. A navigation bar includes links for "About", "40552", and "Login". The main content area displays "Node 40552 - Bubble Chart" above a table with columns: Node, Node Information, Received, Link, Direction, Connected, and Mode. The table content shows "No connections." At the bottom, there is a footer: "Site by WD6AWP. [There are some who call me... Tim?](#)"

Node	Node Information	Received	Link	Direction	Connected	Mode
No connections.						

Set AllMon Login

- **Set AllMon2 user name(s) and password(s)**
 - `cd /srv/http/allmon2`
 - `htpasswd -cd .htpasswd admin`
 - `htpasswd -d .htpasswd <userid>`
- **Password can only contain A-Z a-z 0-9**
 - If you want to use additional characters change *login.php* line 28 from
`if(!ctype_alnum($pass)){`
to
`if(preg_match("[^A-Za-z0-9\.\!\|\$]", $pass)){`
including all the characters you want to allow

Base Access

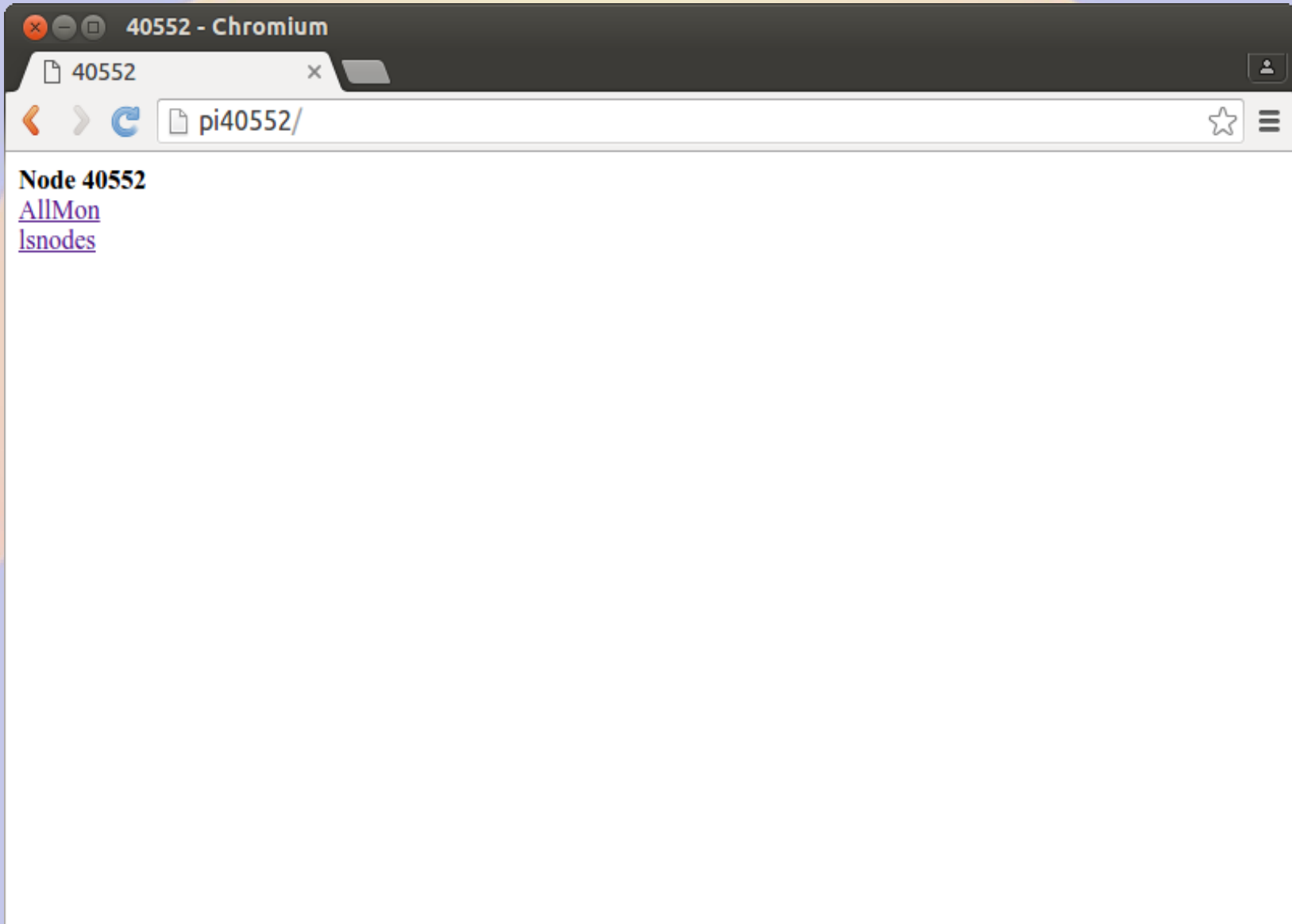

Isnode

Allstar Connected Nodes and Status - Chromium

Allstar Connected N x

pi40552/cgi-bin/lnodes_web?node=40552

Status for AC0KQ - Node 40552

Last update - 05/11/2016 20:04:14 My IP - 66.109.219.132

[View this Node Graphically](#) [Search/Command another Node](#)

Selected system state	0
Signal on Input	NO
System	ENABLED
Parrot Mode	DISABLED
Scheduler	ENABLED
Tail Time	STANDARD
Time out timer	ENABLED
Incoming connections	ENABLED
Time out timer state	RESET
Time outs since system Initialization	0
Identifier state	CLEAN
Kerchunks today	7
Kerchunks since system Initialization	7
Keyups today	12
Keyups since system Initialization	12
DTMF commands today	1
DTMF commands since system Initialization	1
Last DTMF command executed	81
TX time today	00:00:44211
TX time since system Initialization	00:00:44211
Uptime	01:25:06
Nodes currently connected to us	
Autopatch	ENABLED
Autopatch state	DOWN
Autopatch called number	N/A
Reverse patch/IAXRPT connected	DOWN
User linking commands	ENABLED
User functions	ENABLED

Node	Call	Description	Location
40552	AC0KQ	446.200	portable

Node	Peer	Reconnects	Direction	Connect Time	Connect State
Host			Node	State	
67.215.233.178:4569			40552	Registered	

AllMon2

PI40552 | Allmon | 40552 - Chromium

PI40552 | Allmon | 4 x

pi40552/allmon2/link.php?nodes=40552

Allstar Monitor II

Monitoring the World One Node at a Time



About 40552 Logout

29571 Permanent

Connect Disconnect Monitor Local Monitor Control Panel

Node 40552 - AC0KQ 446.200 portable [Bubble Chart](#)

Node	Node Information	Received	Link	Direction	Connected	Mode
No connections.						

*

Site by WD6AWP. [There are some who call me... Tim?](#)

Connect to node 29571

PI40552 | Allmon | 40552 - Chromium

PI40552 | Allmon | 4 x

pi40552/allmon2/link.php?nodes=40552

Allstar Monitor II

Monitoring the World One Node at a Time



About 40552 Logout

29571 Permanent

Connect Disconnect Monitor Local Monitor Control Panel

Node 40552 - AC0KQ 446.200 portable [Bubble Chart](#)

Node	Node Information	Received	Link	Direction	Connected	Mode
29571	AC0KQ 447.850- Evergreen, CO	Never	ESTABLISHED	OUT	00:00:24	Transceive

*

Site by WD6AWP. [There are some who call me... Tim?](#)

Incoming Audio

PI40552 | Allmon | 40552 - Chromium

PI40552 | Allmon | 4 x

pi40552/allmon2/link.php?nodes=40552

Allstar Monitor II

Monitoring the World One Node at a Time



About 40552 Logout

29571 Permanent

Connect Disconnect Monitor Local Monitor Control Panel

Node 40552 - AC0KQ 446.200 portable [Bubble Chart](#)

Node	Node Information	Received	Link	Direction	Connected	Mode
29571	AC0KQ 447.850- Evergreen, CO	000:00:15	ESTABLISHED	OUT	00:02:02	Transceive

*

Site by WD6AWP. [There are some who call me... Tim?](#)

Example Control Panel Display

Allmon Node 40552 Control Panel - Chromium

pi40552/allmon2/controlpanel.php?node=40552

Allstar Monitor II

Allmon Node 40552 Control Panel



Control (select one):

```
==== rpt stats 40552 =====
ActionID: cpAction_692748876
***** NODE 40552 STATISTICS *****

Selected system state.....: 0
Signal on input.....: NO
System.....: ENABLED
Parrot Mode.....: DISABLED
Scheduler.....: ENABLED
Tail Time.....: STANDARD
Time out timer.....: ENABLED
Incoming connections.....: ENABLED
Time out timer state.....: RESET
Time outs since system initialization.....: 0
Identifier state.....: QUEUED FOR CLEANUP
Kerchunks today.....: 3
Kerchunks since system initialization.....: 3
Keyups today.....: 10
Keyups since system initialization.....: 10
DTMF commands today.....: 0
DTMF commands since system initialization.....: 0
Last DTMF command executed.....: N/A
TX time today.....: 00:01:03.787
TX time since system initialization.....: 00:01:03.787
Uptime.....: 00:22:54
Nodes currently connected to us.....: 29571
Autopatch.....: ENABLED
Autopatch state.....: DOWN
Autopatch called number.....: N/A
Reverse patch/IAXRPT connected.....: DOWN
User linking commands.....: ENABLED
User functions.....: ENABLED

--END COMMAND--
```

Site by WD6AWP. [There are some who call me... Tim?](#)

Observations

- **By default the node list is updated daily via a cron job**
- **The rPi uses simpleusb due to limited CPU performance**
- **AllStar uses ArchLinux**
- **There is no need to expand the OS to fill the SD card (image size 4GB)**

A stylized illustration of a sun rising over a mountain range. The sun is a large, semi-circular shape with a gradient from yellow to orange, positioned in the upper half of the frame. Below it, a range of blue mountains is visible, with the sun's rays appearing to illuminate the peaks. The background is a solid light blue color.

Part 4

Control and Monitoring

Raspberry Pi Header

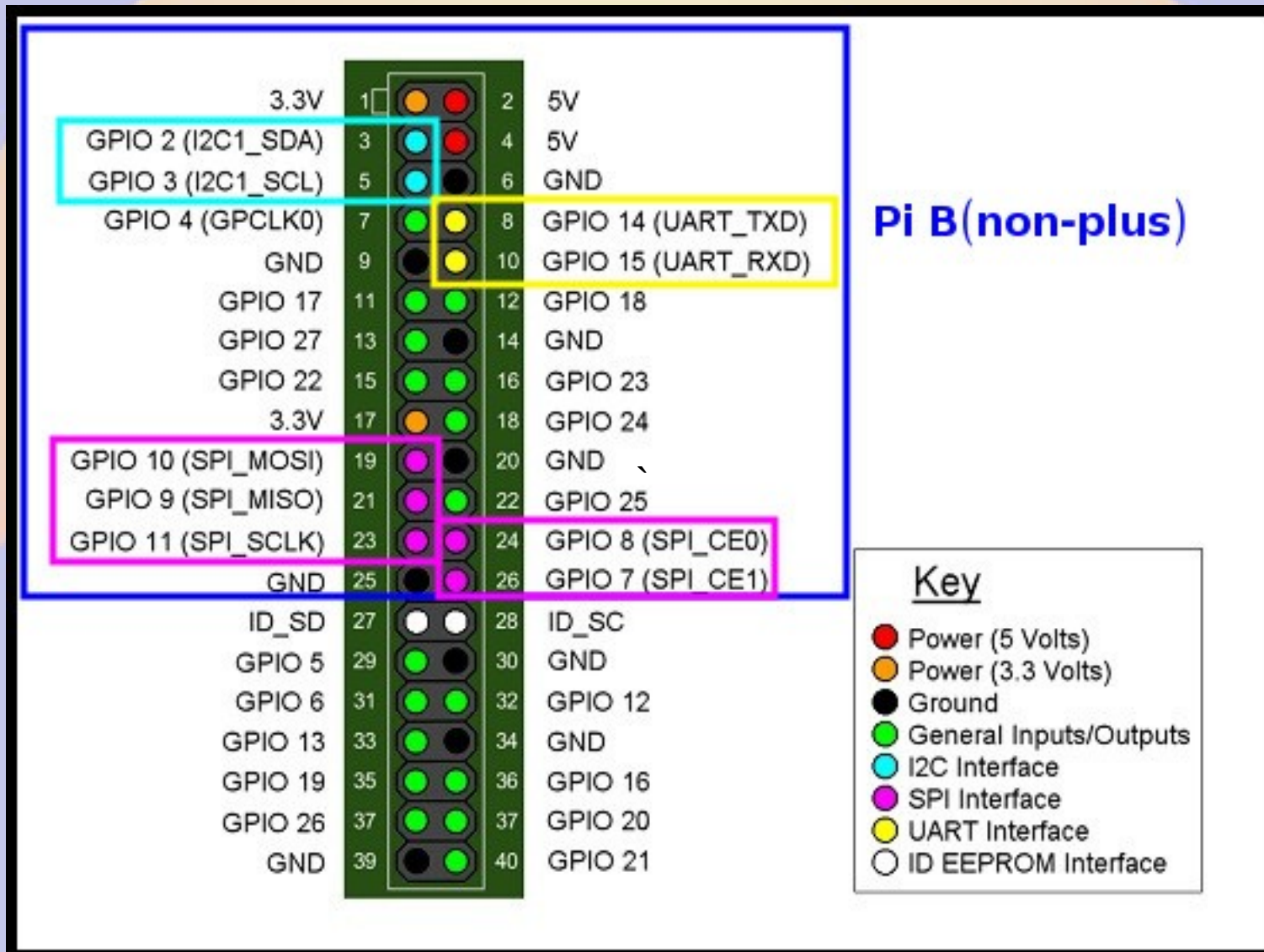

Pins are multiplexed

- Pins configured for different uses
- GPIO 14&15 \Leftrightarrow UART TxD/RxD
- GPIO 2&3 \Leftrightarrow I²C SDA&SCL
- GPIO 7&8&9&10&11 \Leftrightarrow
SPI MOSI&MISO&SCL&CE0&CE1
- GPIO 18&19 \Leftrightarrow PWM 0&1
- 16-26 GPIO pins

Raspberry Pi Serial

- **Single serial port**
 - `/dev/ttyAMA0`
- **Speeds up to 115200 bps**
- **TTL level signals**
- **By default connected to getty**

Raspberry Pi I²C

- **Inter-Integrated Circuit**
 - Serial bus (a.k.a SMBus)
- **Default speed 400,000 bps**
- **rPi has single external I²C bus**
 - 127 devices
- **Control lines**
 - SDA (data)
 - SCL (clock)

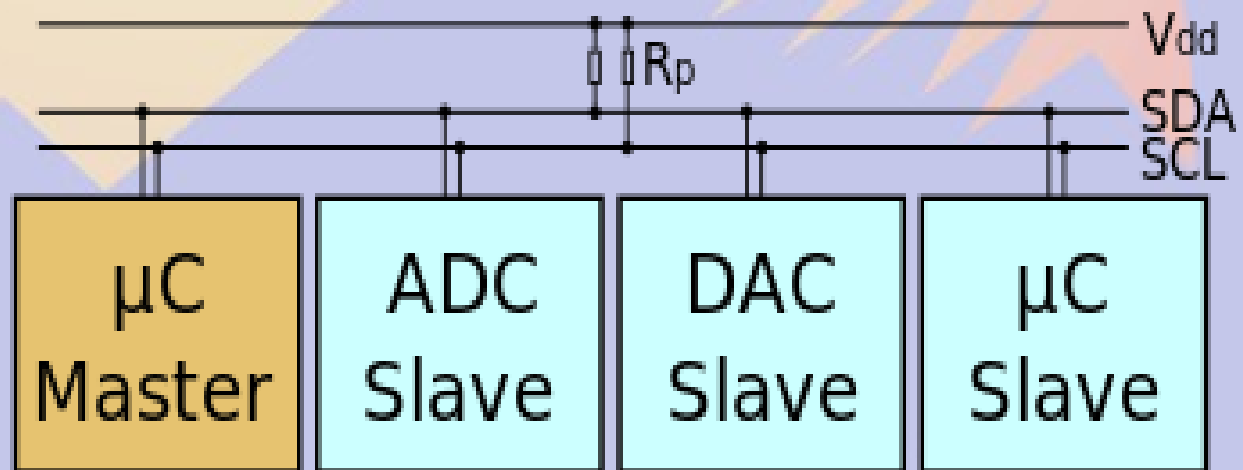

Enable I²C with raspi-config 1

```
pi@raspberrypi: ~  
File Edit View Search Terminal Help  
  
Raspberry Pi Software Configuration Tool (raspi-config)  
  
1 Expand Filesystem          Ensures that all of the SD card s  
2 Change User Password      Change password for the default u  
3 Boot Options              Choose whether to boot into a des  
4 Wait for Network at Boot  Choose whether to wait for networ  
5 Internationalisation Options Set up language and regional sett  
6 Enable Camera             Enable this Pi to work with the R  
7 Add to Rastrack           Add this Pi to the online Raspber  
8 Overclock                 Configure overclocking for your P  
9 Advanced Options          Configure advanced settings  
0 About raspi-config        Information about this configurat  
  
                <Select>                <Finish>
```

Enable I²C with raspi-config 2

```
willem@aid2: ~  
File Edit View Search Terminal Help  
  
Raspberry Pi Software Configuration Tool (raspi-config)  
  
A1 Overscan          You may need to configure oversca  
A2 Hostname          Set the visible name for this Pi  
A3 Memory Split     Change the amount of memory made  
A4 SSH               Enable/Disable remote command lin  
A5 Device Tree      Enable/Disable the use of Device  
A6 SPI               Enable/Disable automatic loading  
A7 I2C              Enable/Disable automatic loading  
A8 Serial            Enable/Disable shell and kernel m  
A9 Audio             Force audio out through HDMI or 3  
AA GL Driver         Enable/Disable experimental desk  
  
                <Select>                <Back>
```

i2cdetect outputs

- **Scans bus looking for devices**
 - - No Device answered
 - UU Device in use by a driver
 - dd Slave found (dd hex adress)
- **Watch for devices in use from user space (e.g. BPQ)**
 - can corrupt data

I²C devices

- **TNC-Pi**
- **INA219 current sensor**
- **Temperature/pressure/RH sensors**
- **LCD displays**
- **Accelerometers**
- **Digital I/O pins**
- **Analog<>Digital I/P pins**

SPI bus

- **Serial Peripheral Interface**
- **Signals (supports 2 slaves)**
 - MasterOutSlaveIn
 - MasterInSlaveOut
 - **Clock**
 - **CE0 (SS1)**
 - **CE1 (SS2)**
- **Speeds up to 250 MHz**

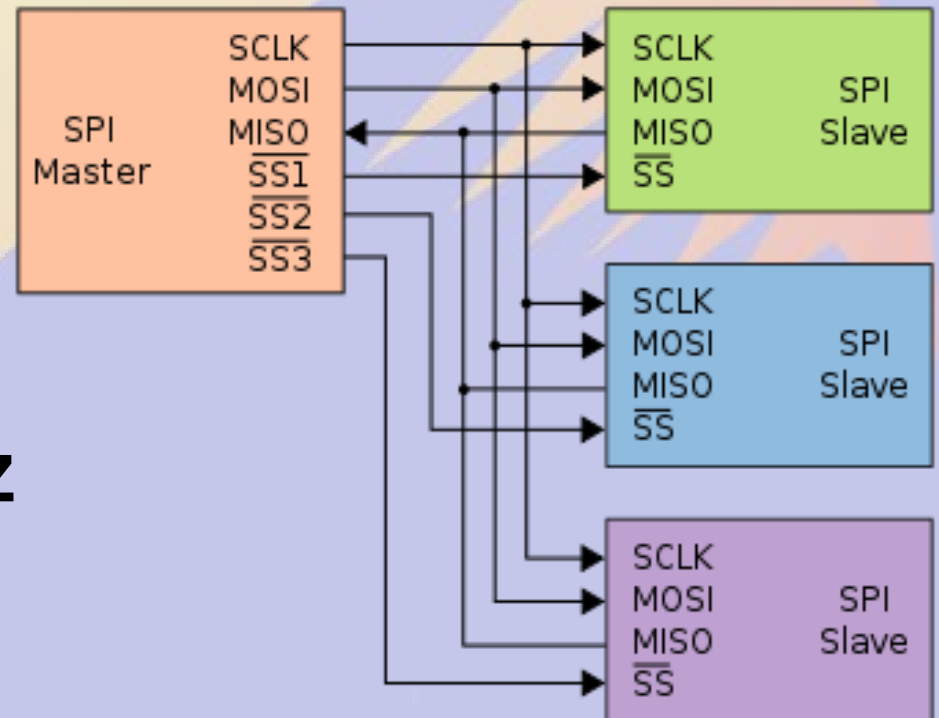

raspi-config enable SPI

```
willem@aid2: /sys/bus/i2c/drivers/stmpe-i2c
File Edit View Search Terminal Help

Raspberry Pi Software Configuration Tool (raspi-config)

A1 Overscan          You may need to configure oversca
A2 Hostname          Set the visible name for this Pi
A3 Memory Split      Change the amount of memory made
A4 SSH               Enable/Disable remote command lin
A5 Device Tree       Enable/Disable the use of Device
A6 SPI               Enable/Disable automatic loading
A7 I2C               Enable/Disable automatic loading
A8 Serial            Enable/Disable shell and kernel m
A9 Audio             Force audio out through HDMI or 3
AA GL Driver         Enable/Disable experimental desk

<Select>           <Back>
```

SPI Devices

- **Faster than I²C, but uses more pins**
- **Same devices as I²C, but adds**
 - **GPS**
 - **Ethernet/WiFi/Bluetooth/RFID**
 - **Memory**
- **Full duplex**

Beagle Bone Black

Cape Expansion Headers

P9

DGND	1	2	DGND
VDD_3V3	3	4	VDD_3V3
VDD_5V	5	6	VDD_5V
SYS_5V	7	8	SYS_5V
PWR_BTN	9	10	SYS_RESETN
UART4_RXD	11	12	GPIO_60
UART4_TXD	13	14	EHRPWM1A
GPIO_48	15	16	EHRPWM1B
SPIO_CS0	17	18	SPIO_D1
I2C2_SCL	19	20	I2C2_SDA
SPIO_DO	21	22	SPIO_SCLK
GPIO_49	23	24	UART1_TXD
GPIO_117	25	26	UART1_RXD
GPIO_115	27	28	SPI1_CS0
SPI1_DO	29	30	GPIO_112
SPI1_SCLK	31	32	VDD_ADC
AIN4	33	34	GNDA_ADC
AIN6	35	36	AIN5
AIN2	37	38	AIN3
AIN0	39	40	AIN1
GPIO_20	41	42	ECAPPWMO
DGND	43	44	DGND
DGND	45	46	DGND

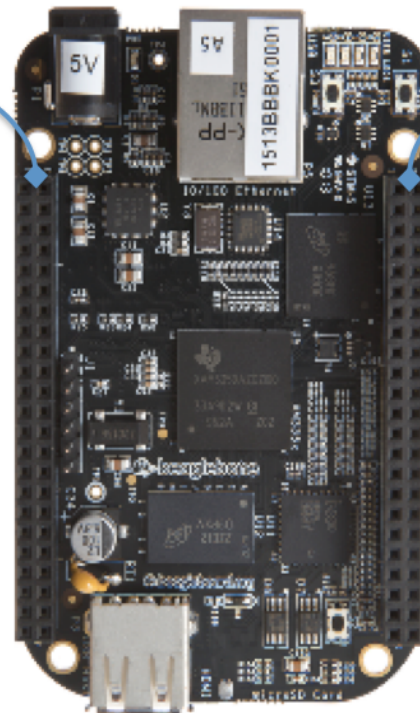

P8

DGND	1	2	DGND
MMC1_DAT6	3	4	MMC1_DAT7
MMC1_DAT2	5	6	MMC1_DAT3
GPIO_66	7	8	GPIO_67
GPIO_69	9	10	GPIO_68
GPIO_45	11	12	GPIO_44
EHRPWM2B	13	14	GPIO_26
GPIO_47	15	16	GPIO_46
GPIO_27	17	18	GPIO_65
EHRPWM2A	19	20	MMC1_CMD
MMC1_CLK	21	22	MMC1_DAT5
MMC1_DAT4	23	24	MMC1_DAT1
MMC1_DAT0	25	26	GPIO_61
LCD_VSYNC	27	28	LCD_PCLK
LCD_HSYNC	29	30	LCD_AC_BIAS
LCD_DATA14	31	32	LCD_DATA15
LCD_DATA13	33	34	LCD_DATA11
LCD_DATA12	35	36	LCD_DATA10
LCD_DATA8	37	38	LCD_DATA9
LCD_DATA6	39	40	LCD_DATA7
LCD_DATA4	41	42	LCD_DATA5
LCD_DATA2	43	44	LCD_DATA3
LCD_DATA0	45	46	LCD_DATA1

LEGEND

POWER/GROUND/RESET

AVAILABLE DIGITAL

AVAILABLE PWM

SHARED I2C BUS

RECONFIGURABLE DIGITAL

ANALOG INPUTS (1.8V)

Pins are multiplexed

- **Default configuration**
 - **Power&Reset Buttons**
 - **4 serial ports**
 - **8 analog inputs (1.8V max)**
 - **1 external I²C bus (127 devices)**
 - **19-128 GPIO pins**
 - **Switched 5V/3.3V DC**

Limitations

- **Pins connect directly to CPU**
 - Long wires are CPU antennas!
- **rPi & BBB GPIO Pins are 3.3 V**
 - Max current 16 mA in or out
 - Max combined output current 50 mA
- **BB Analog In Pins are 1.8V**

Device Tree

- **Unix: Everything is a File**
- **/sys maps to hardware**
 - In kernel virtual file system
- **Get status by reading**
- **Set status by writing**

Reading analog pins on BBB

- Enable analog pins in device tree

```
echo cape-bone-
```

```
iio>/sys/devices/bone_capemgr.*/slots
```

- Read value of pin AIN0 in mV

```
cat /sys/devices/ocp.*/helper.*/AIN0
```

```
580
```

- Voltage on pin AIN0 is 0.580V

Show pin voltages in Python 1

```
#!/usr/bin/python

for i in range(0,8):
    # Snarf file
    fd = open("/sys/devices/ocp.3/helper.16/AIN%d" % i)
    text = fd.read()
    fd.close()
    # Decode voltage
    V = float(text)/1000
    # Print voltage
    print "AIN%d = %5.3fV" % (i,V)
```

Show pin voltages in Python 2

./aread

AIN0 = 1.740V

AIN1 = 1.481V

AIN2 = 1.645V

AIN3 = 0.867V

AIN4 = 0.589V

AIN5 = 0.709V

AIN6 = 0.852V

AIN7 = 1.678V

Limitations

- **Maximum voltage is 1.8V**
- Use a voltage divider to increase
 - Use 1% or better resistors
 - Max 1 kohm for lower leg
- No analog in on rPi
 - use MCP3008 or similar and SPI

Assigning pins to GPIO

- **`/sys/class/gpio/export`**
 - Maps pin to GPIO
 - `echo 18 > /sys/class/gpio/export`
- **`/sys/class/gpio/unexport`**
 - Removes pin from GPIO map
 - `echo 18 > /sys/class/gpio/unexport`
- Root access required

Manipulating GPIO

- **When mapped to GPIO, a new directory is created for that pin**
 - */sys/class/gpio/gpioXX*
- Files in this directory controls pin
 - direction = in or out
 - value = 0 or 1

Checking pin value

- In or out?
 - **cat /sys/class/gpio/gpio18/direction**
- High or low?
 - **cat /sys/class/gpio/gpio18/value**

Changing the GPIO direction

- Set pin for input
 - `echo in > /sys/class/gpio/gpio18/direction`
- Set pin for output
 - `echo out > /sys/class/gpio/gpio18/direction`

Changing the GPIO value

- Set pin voltage high
 - `echo 1 > /sys/class/gpio/gpio18/value`
- Set pin for output
 - `echo 0 > /sys/class/gpio/gpio18/value`

Setting pins at boot

- Edit **`/etc/rc.local`**

- Runs at boot time as root

- Enable pin 18 for output and set high

- `echo 18 > /sys/class/gpio/export`**

- `echo out > /sys/class/gpio/gpio18/direction`**

- `echo 1 > /sys/class/gpio18/value`**

- Before this runs, values are unpredictable

Setting many pins at boot

- Edit `/etc/rc.local`
 - Set pin 18, 23, 24 and 25 for output and high
- ```
Set GPIO ports to out
for n in 18 23 24 25; do
 echo $n > /sys/class/gpio/export
 echo "out" >
 /sys/class/gpio/gpio$n/direction
 echo 1 > /sys/class/gpio/gpio$n/value
done
```

# Turn on pin 5 minutes per hour

- Edit **`/etc/crontab`**

```
This line turns on pin 18 at *:0
```

```
0 * * * * root echo 1 > /sys/class/gpio/gpio18/value
```

```
This line turns off pin 18 at *:5
```

```
5 * * * * root echo 0 > /sys/class/gpio/gpio18/value
```

# python access to pins

- **Import the GPIO package**  
`import Rpi.GPIO as GPIO`
- **Name the pins by their GPIO#**  
`GPIO.setmode(GPIO.BCM)`
- **Name pins by their board number**  
`GPIO.setmode(GPIO.BOARD)`



# python set pins for in/out

- **Set pin 18 for output**

**GPIO.setup(18,GPIO.OUT)**

- **Set pins 18,23,24&25 for output**

**GPIO.setup([18,23,24,25],GPIO.OUT)**

- **Set pin 18 for input**

**GPIO.setup(18,GPIO.IN)**

# python set/get pin value

- **Set pin 18 high**  
**GPIO.output(18,1)**
- **Set pin 18 low**  
**GPIO.output(18,0)**
- **Read pin 18 value**  
**p18 = GPIO.input(18)**

# Input pin status

- Set pin 23 to input with pull up
- `GPIO.setup(24,GPIO.IN,pull_up_down=GPIO.PUD_UP)`
  - ground to activate
- Set pin 24 to input with pull down
- `GPIO.setup(24,GPIO.IN,pull_up_down=GPIO.PUD_DOWN)`
  - Pull up to 3.3V
- A 1k series resistor is typically a good idea

# Important Limitations

- GPIO pins are 3.3 V
- Current limited to 16mA
- Opto-isolate relays

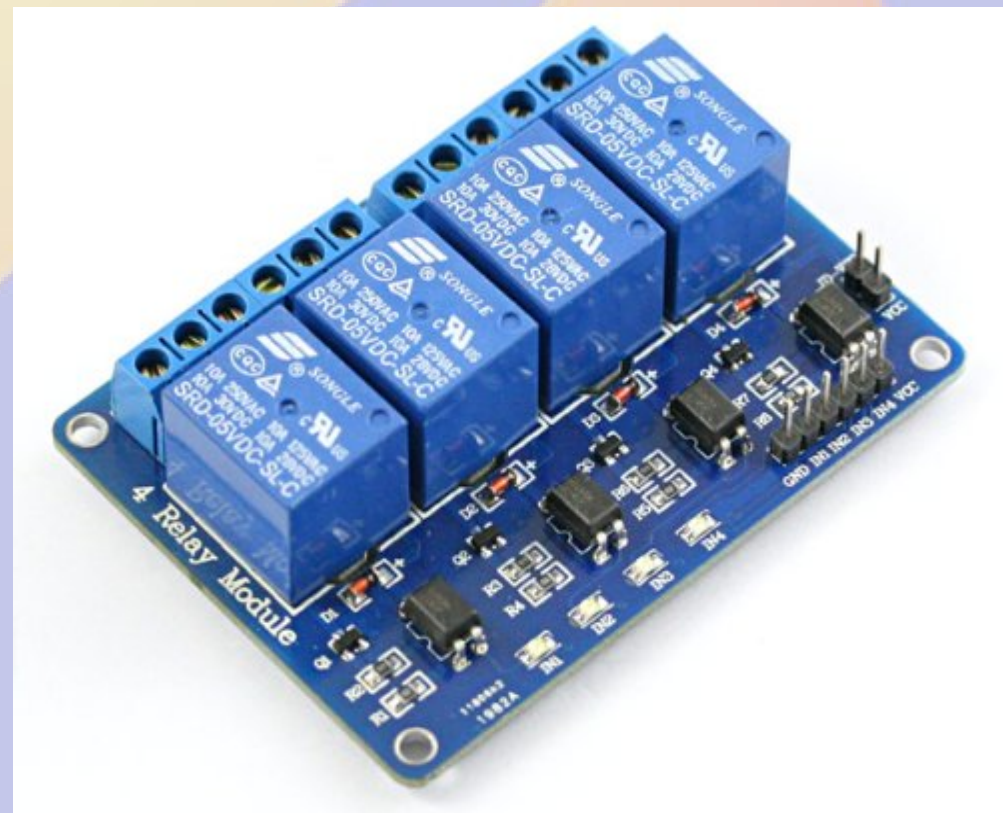

# I<sup>2</sup>C Example: Voltage & Current

- TI INA219 I<sup>2</sup>C high side monitor
- Max 26V
- Current Sense  
40-320mV  
shunt
- Chip \$2.50
- Adafruit \$10

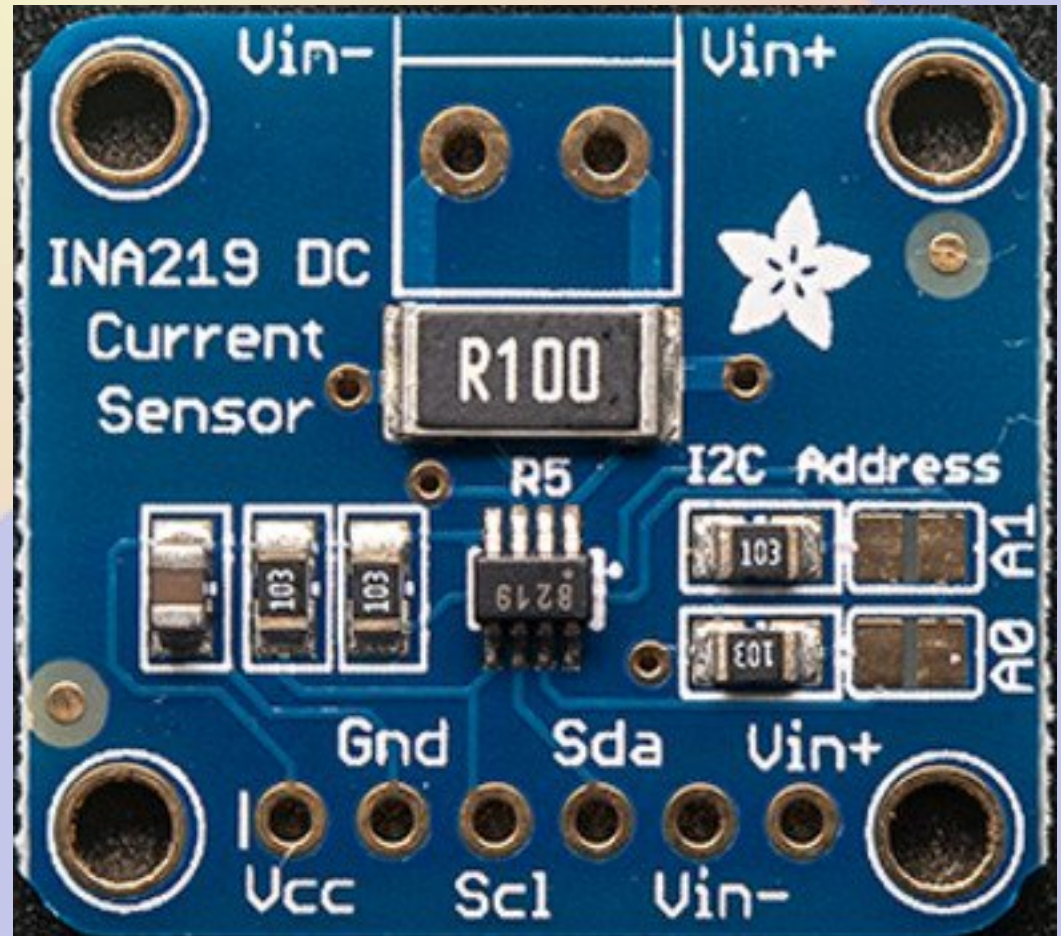



# Adafruit Breakout

- I<sup>2</sup>C address 0x40 0x41 0x42 0x43
  - solder jumpers
- 0.1 ohm shunt reads to 3.2A

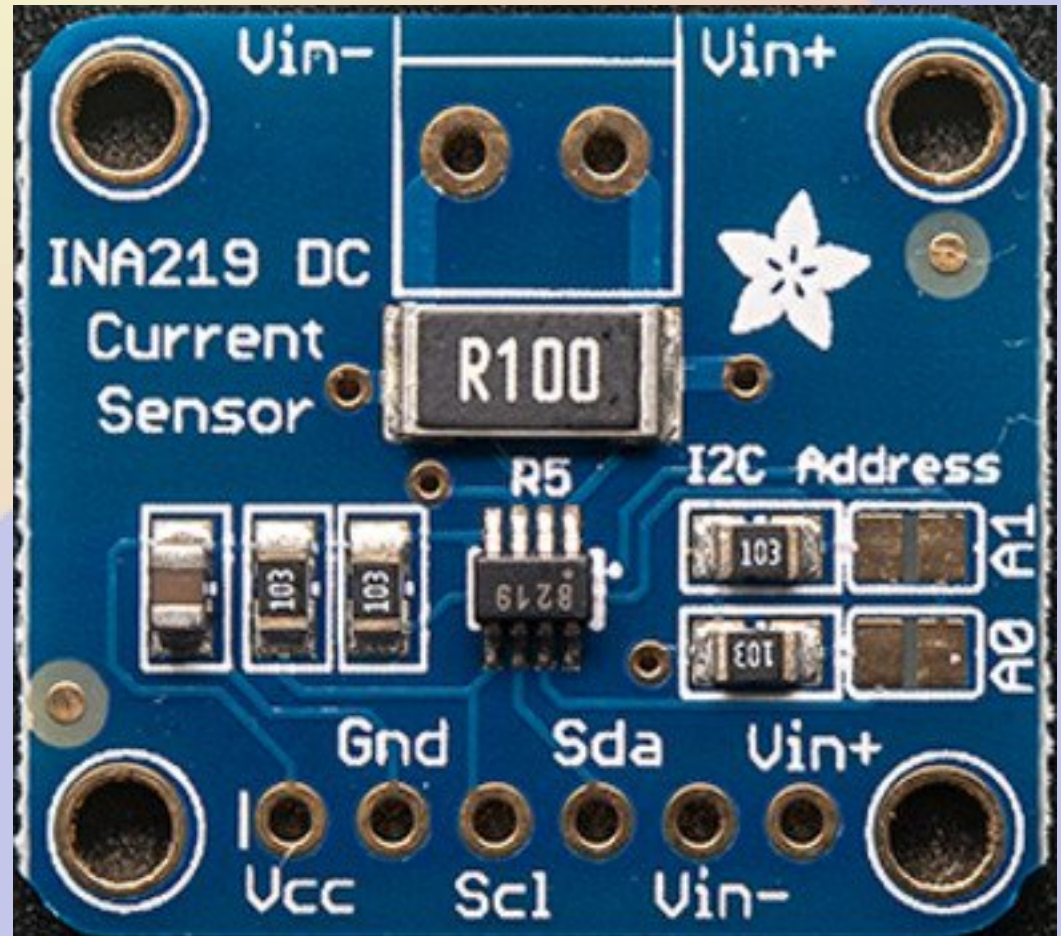

# Python Usage

```
import Subfact_INA219 as INA219
ina = INA219()
V = ina.getBusVoltage_V()
mA = ina.getCurrent_mA()
```

# Digging deeper

- **Subfact\_INA219 imports Adafruit\_I2C**
- **Adafruit\_I2C imports smbus**
- **def getBusVoltage():**  
    **res = i2c.readU16(0x02)**  
    **mV = (res >> 3) \* 4**  
    **return 0.001\*mV**



# Reading 1wire Temperatures

- **1wire uses a single data bus**
- **Each device has unique address**
- **DS18S20 is a TO-92 temperature sensor with 0.5C resolution for \$2.50**
- **Can use parasite power (but not on rPi)  
Use 4k7 pullup**

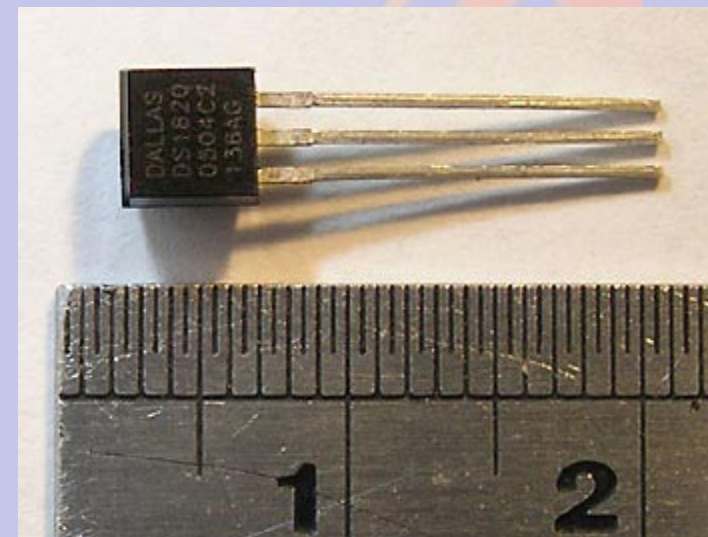

# Building the Device Tree 1

```
/dts-v1/;
/plugin/;

/ {
 compatible = "ti,beaglebone", "ti,beaglebone-black", "ti,beaglebone-green";
 part-number = "BB-W1";
 version = "00A0";

 exclusive-use = "P9.23";

 fragment@0
 {
 target = <&am33xx_pinmux>;
 __overlay__
 {
 bb_w1_pins: pinmux_bb_w1_pins
 {
 pinctrl-single,pins = <0x68 0x37>; /* gpio1_17,
 OMAP_PIN_INPUT_PULLUP|OMAP_MUX_MODE7 */
 };
 };
 };
};
```

# Building the Device Tree 2

```
fragment@1
{
 target = <&ocp>;
 __overlay__
 {
 onewire@0
 {
 status = "okay";
 compatible = "w1-gpio";
 pinctrl-names = "default";
 pinctrl-0 = <&bb_w1_pins>;

 gpios = <&gpio2 17 0>;
 };
 };
};
```

# Building the Device Tree 3

- Edit `w1.dts` as shown above

- Compile with device tree compiler

```
dtc -O dtb -o w1-00A0.dtbo -b 0 -@ w1.dts
```

```
mv w1-00A0.dtbo /lib/firmware
```

- Enable

```
echo w1 > /sys/devices/bone_capemgr.9/slots
```

# Getting 1wire output

- **ls /sys/bus/w1/devices**

```
10-000802fba50d
```

```
10-000802fbe2f6
```

```
10-000802fbf0f9
```

```
w1_bus_master1
```

- **10 means it is a DS18S20 temp, the test is a unique serial number**

# Getting the Data

```
cat /sys/bus/w1/devices/w1_bus_master1/w1_master_slaves
```

```
10-000802fbe2f6
```

```
10-000802fbf0f9
```

```
10-000802fba50d
```

```
cat /sys/bus/w1/devices/10-000802fbe2f6/w1_slave
```

```
2c 00 4b 46 ff ff 0e 10 17 : crc=17 YES
```

```
2c 00 4b 46 ff ff 0e 10 17 t=21875
```

Temperature of first sensor is 21.875 °C

# Reading Temps in Python 1

```
Snarf the slave list file
fd=open("/sys/bus/w1/devices/w1_bus_master1/w1_master_slaves")
text = fd.read()
fd.close()
Split text on line breaks
slaves = filter(None,text.split("\n"))
Sort so that order is predictable
slaves.sort()
```

# Reading Temps in Python 2

```
Blank dictionary
temps = {}
Loop over devices
for slave in slaves:
 if slave=="": continue
 # Snarf device file
 fd = open("/sys/bus/w1/devices/"+slave+"/w1_slave")
 text = fd.read()
 fd.close()
 # Split lines
 lines = text.split("\n")
 words = lines[1].split(" ")
 # Get temperature
 C = float(words[9][2:])/1000
 F = 9*C/5+32
 # Add result to dictionary
 temps[slave] = "%.1fF" % F
```



# Observations

- **Temperature conversion occurs when you cat the file**
  - About 700mS per device
- **Temperature reads are best done using a separate thread**
- **rPi 1wire support in *raspi-config***

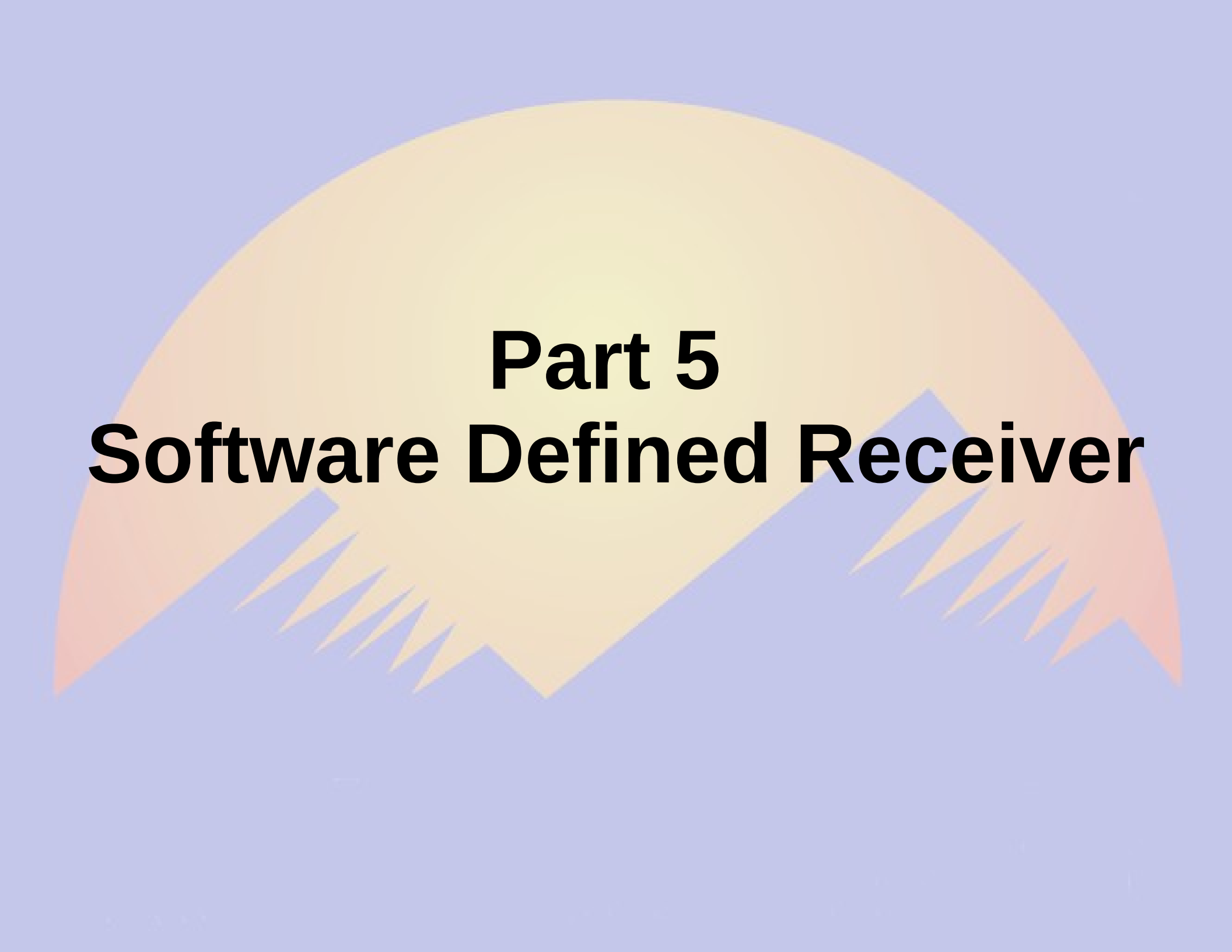

# **Part 5**

# **Software Defined Receiver**

# ADSB SDR Receiver

- Receiver based on RTL2832 USB
- About \$20 on Amazon
- Also used in many ham related SDR projects



# Software Build

## Build and install rtl-sdr module and software

```
git clone git://git.osmocom.org/rtl-sdr.git
cd rtl-sdr
mkdir build
cd build
cmake ../ -DINSTALL_UDEV_RULES=ON
make
cd ..
```

**/usr/local/bin/rtl\_tcp** is a TCP server for remote monitoring

# dump1090 Build

## Build and install dump1090 and related software

```
git clone git://github.com/MalcolmRobb/dump1090.git
cd dump1090
make
cd ..
```

# Command line interface

- `./view1019`

```
willem@adsb: /usr/local/bin
File Edit View Search Terminal Help
Hex Mode Sqwk Flight Alt Spd Hdg Lat Long Sig Msgs Ti/

A1B3FF S 1455 740 18025 331 036 39.419 -105.146 20 134 1
ACF600 S 33975 12 27 5
A50119 S 2406 UAL1881 34025 15 172 5
```

# Running web interface

- **`./dump1090 --net --lon -105 --lat 39`**
  - `--net` enables web interface port 8080**
  - `--lon` and `--lat` sets location**
- **Run at boot from rc.local**

# Running

DUMP1090 - Chromium

DUMP1090

adsb:8080

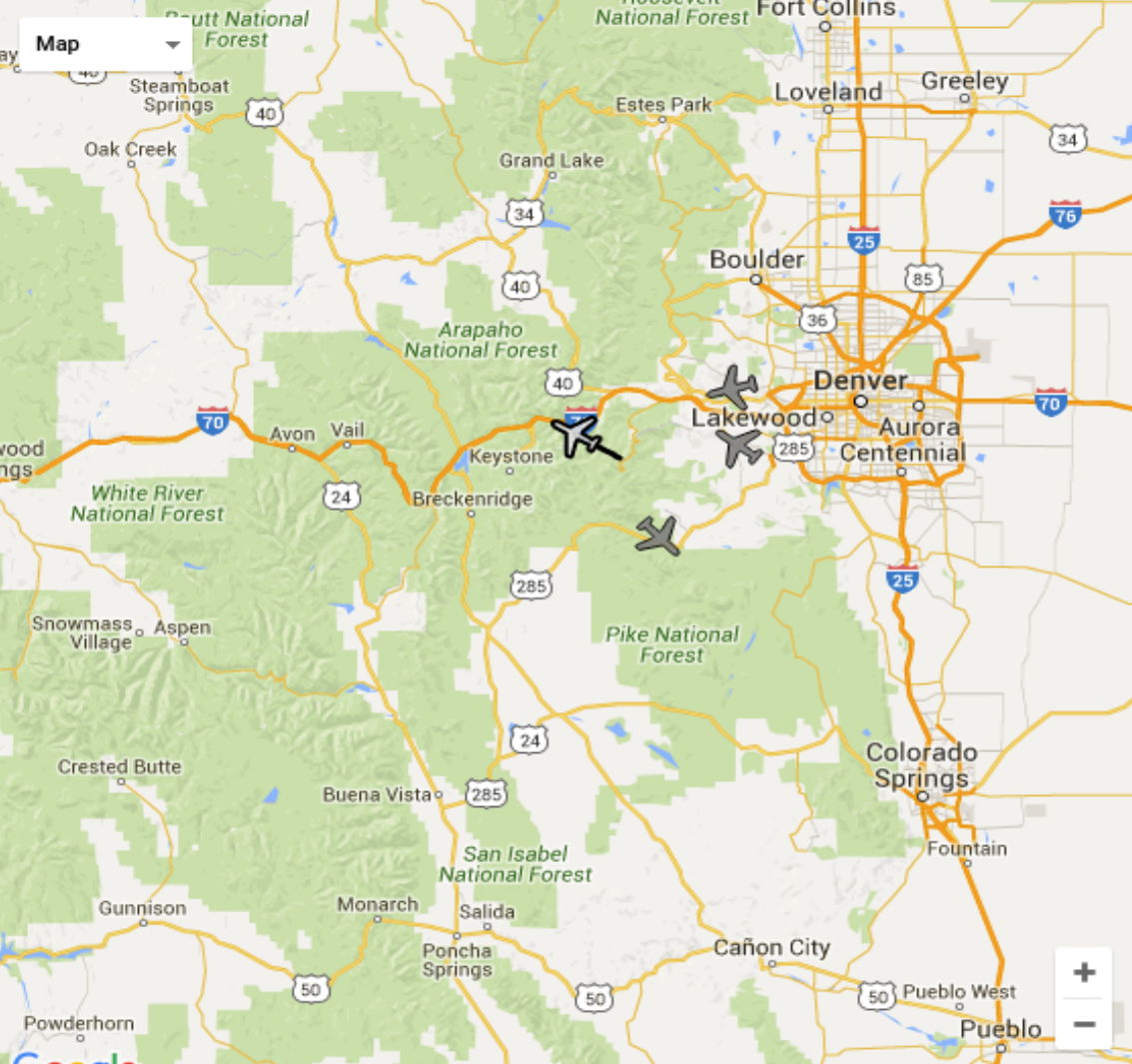

Map

Local Time 

UTC Time 

[ Reset Map ] [ Settings ]

**AAL1355** [\[FR24\]](#) [\[FlightStats\]](#) [\[FlightAware\]](#)

Altitude: 36000 ft Squawk: 6251  
Speed: 396 kt ICAO (hex): ab6fdd  
Track: 300° (NW)  
Lat/Long: 39.663391, -105.759828

| ICAO   | Flight  | Squawk | Altitude | Speed | Track | Msgs | Seen |
|--------|---------|--------|----------|-------|-------|------|------|
| albabb | CPZ5932 | 2732   | 19100    | 344   | 255   | 46   | 0    |
| ab6fdd | AAL1355 | 6251   | 36000    | 396   | 300   | 512  | 5    |
| a0f828 | DAL17   | 7240   | 38000    | 426   | 306   | 399  | 0    |
| a0a092 |         |        | 44975    | 451   | 136   | 121  | 10   |

Google

Map data ©2016 Google Terms of Use Report a map error



# Building a high gain antenna

- Colinear made from coax

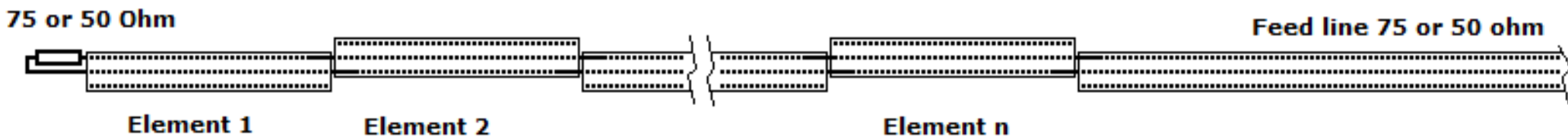

- Mount on N female inside PVC pipe



# Installation

- **Mount the receiver as close to the antenna as possible**
  - RTL-SDR is not weather proof
  - 18" N to micro-UHF jumper
- **Run long USB cable to rPi**

# Other SDR Projects

- The rPi 3 is a 1.2GHz 64 bit quad core machine with 1GB memory
  - Processing power to do cool stuff
- Adafruit Freq Show
- GNU radio

Eric Schneider  
RMHAM U  
April 15, 2017

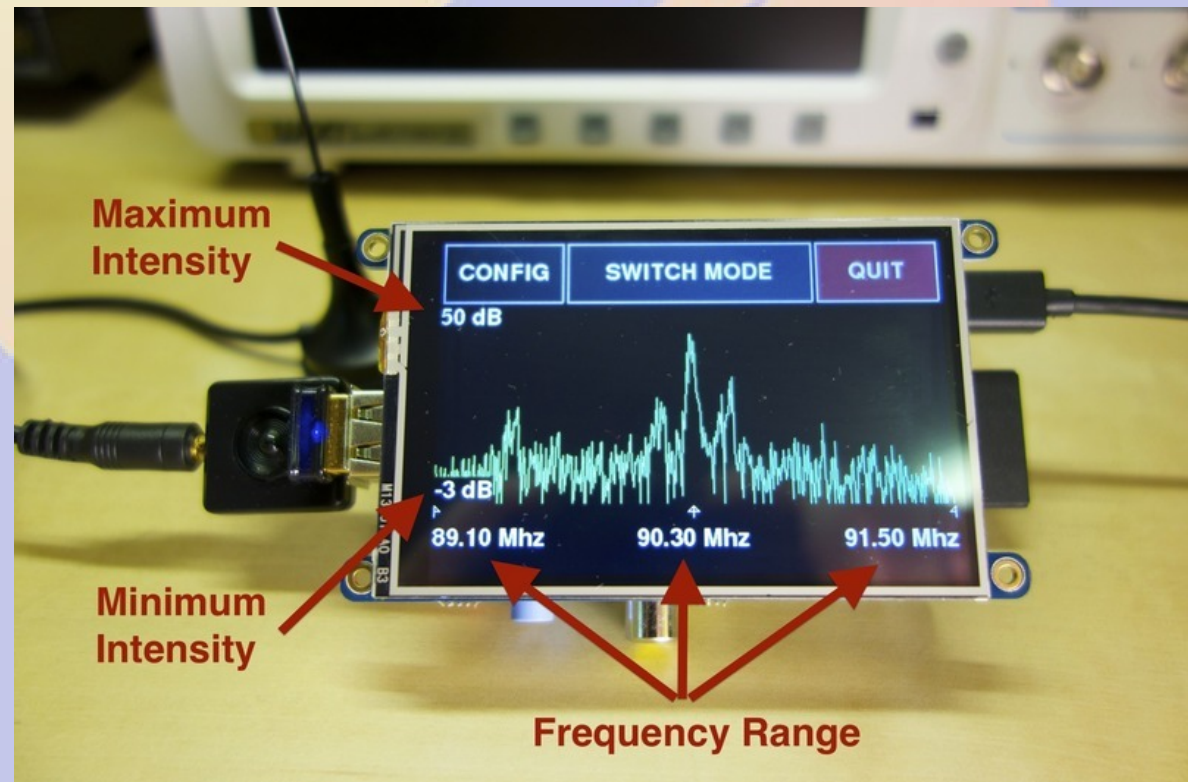

# RasHAWK

Custom User Interface



Spectrum Displays

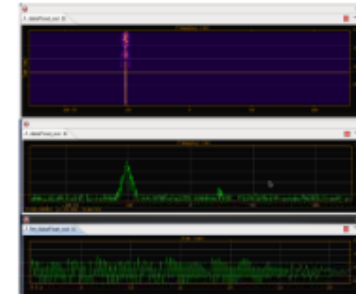

Command & Control (C2) Laptop



GPS

iPhone Hotspot (tether to Internet)



REDHAWK Domain Manager

Location Mapping on Tablet



Control & Streaming Data



WiFi Router  
SSID:  
rashawk\_wlan

Transmitter Node



REDHAWK Device Node

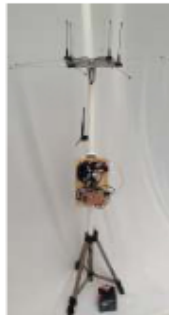

RasHawk Sensors



REDHAWK Device Nodes



Raspberry Pi with Antenna Switch





# SDR TCP server

- Start *rtl\_tcp* as root
  - `rtl_tcp -a <ipaddress>`
  - Default port is 1234 (set with -p)
- Connect to it with an SDR program such as SDR# or GNU Radio on a device with enough power to process the data

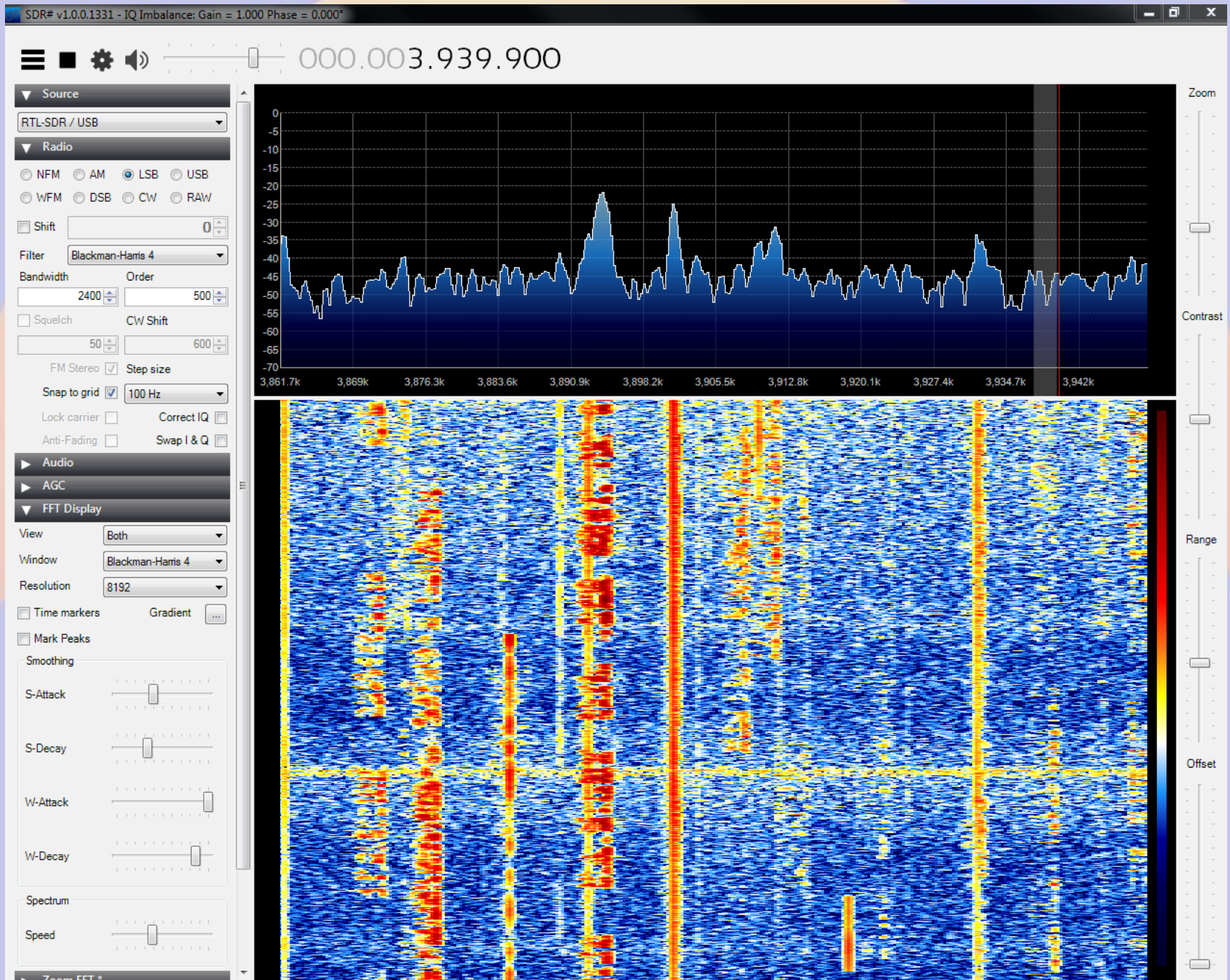

# SDR# Screenshot



A stylized sun with a yellow-to-orange gradient, partially obscured by a blue horizon line. The sun's rays are represented by several blue, triangular shapes pointing upwards from the horizon. The background is a solid light blue color.

# **Part 6**

## **Other Projects**

# rPi / TNC-Pi / screen / xastir





# SmokePi (SmokePing rPi)

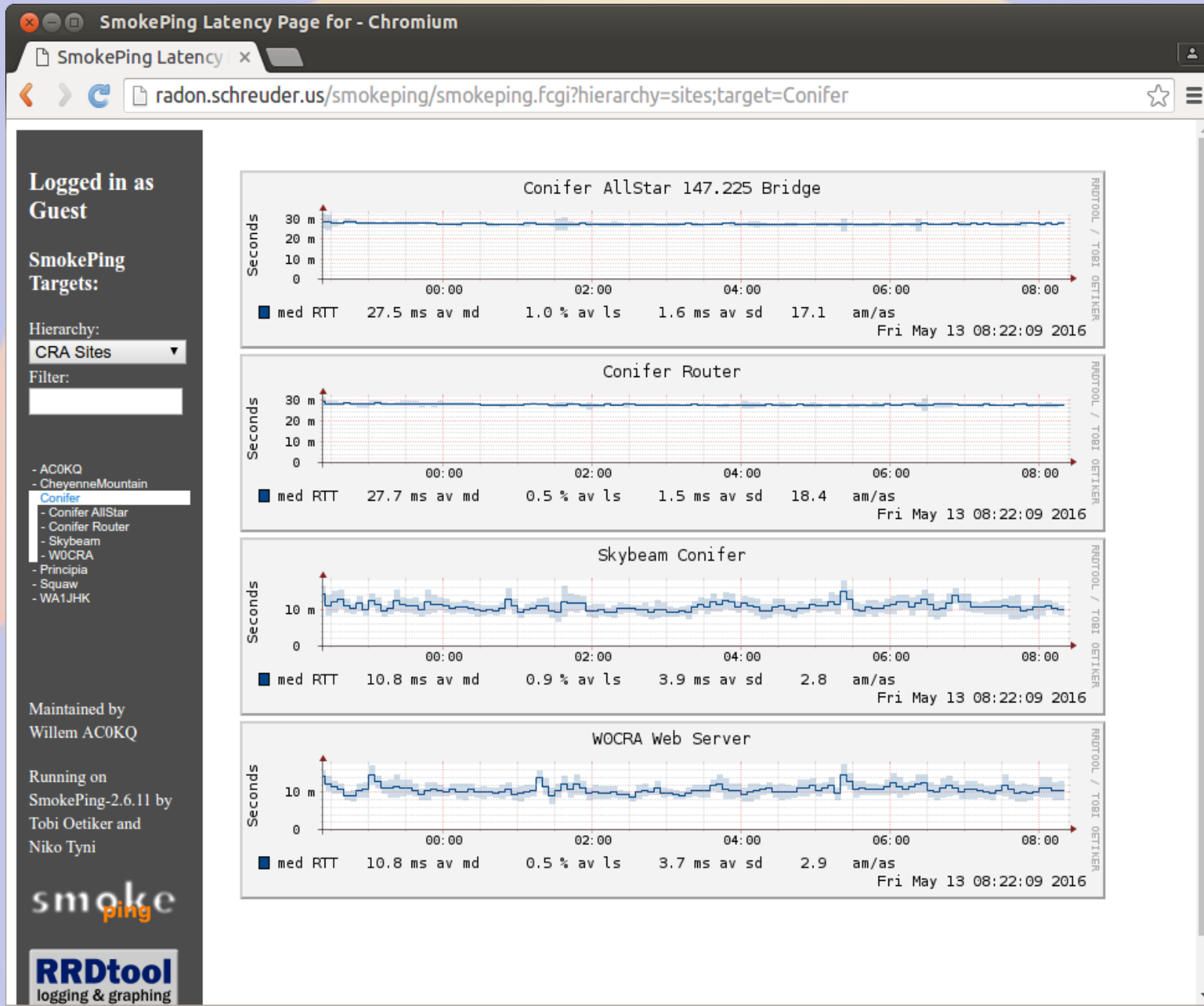

# SmokePi = Bad Idea

- **SD storage not suitable for database applications**
  - Lots of writes wears out flash
- **SmokePi generates lots of graphs**
  - SD slow compared to disk
  - Lots of writes wears out flash
- **USB-mSATA hat allows adding a hard disk**
  - With a SSD drive this becomes feasible

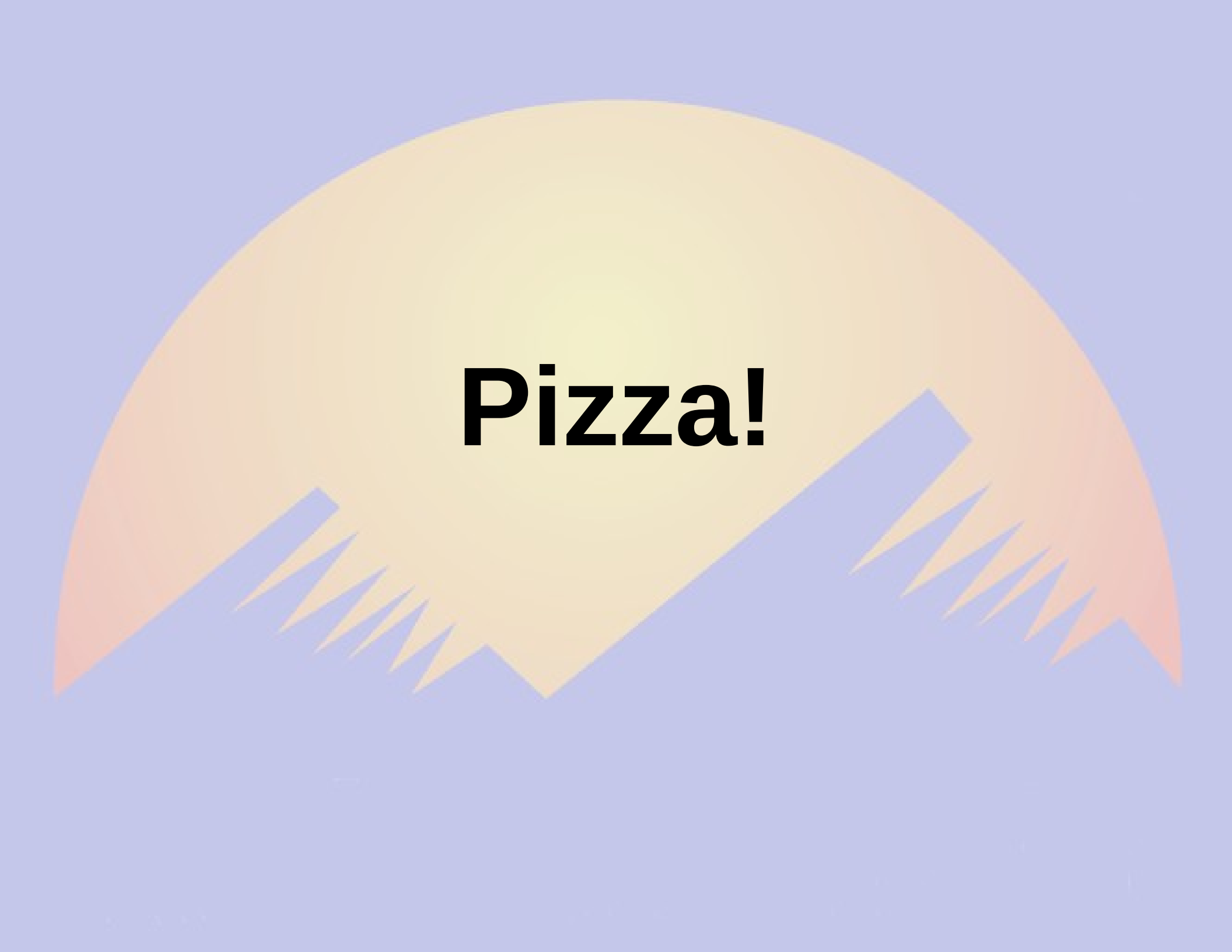
A large, semi-circular sun with a yellow-to-orange gradient is centered in the upper half of the image. The sun is partially obscured by several blue, triangular rays pointing upwards from the bottom edge. The background is a solid light blue color.

**Pizza!**